



INSTRUCTION MANUAL

VHF MARINE TRANSCEIVER IC-M602

This device complies with Part 15 of the FCC rules. Operation is subject to the following two conditions: (1) This device may not cause harmful interference, and (2) this device must accept any interference received, including interference that may cause undesired operation.

Icom Inc.



FOREWORD

Thank you for purchasing this Icom product. The IC-M602 VHF MARINE TRANSCEIVER is designed and built with Icom's state of the art technology and craftsmanship. With proper care, this product should provide you with years of trouble-free operation.

We want to take a couple of moments of your time to thank you for making the IC-M602 your radio of choice, and hope you agree with Icom's philosophy of "technology first." Many hours of research and development went into the design of your IC-M602.

◇ **FEATURES**

- *Standard 4×8" flush mount design*
- *Built-in DSC meets ITU Class D requirement*
- *Rugged waterproof construction*
- *Large LCD with dot matrix characters*
- *Superior receiver performance*
- *Optional COMMANDMIC™
(2 systems are connectable)*

IMPORTANT

READ THIS INSTRUCTION MANUAL CAREFULLY before attempting to operate the transceiver.

SAVE THIS INSTRUCTION MANUAL. This manual contains important safety and operating instructions for the IC-M602.

CLEAN THE TRANSCEIVER AND MICROPHONE THOROUGHLY WITH FRESH WATER after exposure to water including salt water, otherwise, the keys and switches may become inoperable due to salt crystallization.

Icom, Icom Inc. and the  logo are registered trademarks of Icom Incorporated (Japan) in the United States, the United Kingdom, Germany, France, Spain, Russia and/or other countries.

IN CASE OF EMERGENCY

If your vessel requires assistance, contact other vessels and the Coast Guard by sending a distress call on Ch 16.

USING CHANNEL 16

DISTRESS CALL PROCEDURE

1. "MAYDAY MAYDAY MAYDAY."
2. "THIS IS" (name of vessel)
3. Your call sign or other indication of the vessel (AND 9-digit DSC ID if you have one).
4. "LOCATED AT" (your position)
5. The nature of the distress and assistance required.
6. Any other information which might facilitate the rescue.

Or, transmit your distress call using digital selective calling on Ch 70.

USING DIGITAL SELECTIVE CALLING (Ch 70)

DISTRESS CALL PROCEDURE

1. While lifting up the switch cover, push and hold [DISTRESS] for 5 sec. until you hear 5 short beeps change to one long beep.
2. Wait for an acknowledgment from a coast station.
 - Channel 16 is automatically selected.
3. Push and hold [PTT], then transmit the appropriate information as at above.

NOTE

A WARNING STICKER is supplied with the transceiver. To comply with FCC regulations, this sticker must be affixed in such a location as to be readily seen from the operating controls of the radio as in the diagram below. Make sure the chosen location is clean and dry before applying the sticker. (p. 48)

EXAMPLE



RADIO OPERATOR WARNING



WARNING

Icom requires the radio operator to meet the FCC Requirements for Radio Frequency Exposure. An omnidirectional antenna with gain not greater than 9 dBi must be mounted a minimum of 5 meters (measured from the lowest point of the antenna) vertically above the main deck and all possible personnel. This is the minimum safe separation distance estimated to meet all RF exposure compliance requirements. This 5 meter distance is based on the FCC Safe Maximum Permissible Exposure (MPE) distance of 3 meters added to the height of an adult (2 meters) and is appropriate for all vessels.

For watercraft without suitable structures, the antenna must be mounted so as to maintain a minimum of 1 meter vertically between the antenna, (measured from the lowest point of the antenna), to the heads of all persons AND all persons must stay outside of the 3 meter MPE radius.

Do not transmit with radio and antenna when persons are within the MPE radius of the antenna, unless such persons (such as driver or radio operator) are shielded from antenna field by a grounded metallic barrier. The MPE Radius is the minimum distance from the antenna axis that person should maintain in order to avoid RF exposure higher than the allowable MPE level set by FCC.

FAILURE TO OBSERVE THESE LIMITS MAY ALLOW THOSE WITHIN THE MPE RADIUS TO EXPERIENCE RF RADIATION ABSORPTION WHICH EXCEEDS THE FCC MAXIMUM PERMISSIBLE EXPOSURE (MPE) LIMIT. IT IS THE RESPONSIBILITY OF THE RADIO OPERATOR TO ENSURE THAT THE MAXIMUM PERMISSIBLE EXPOSURE LIMITS ARE OBSERVED AT ALL TIMES DURING RADIO TRANSMISSION. THE RADIO OPERATOR IS TO ENSURE THAT NO BYSTANDERS COME WITHIN THE RADIUS OF THE MAXIMUM PERMISSIBLE EXPOSURE LIMITS.

Determining MPE Radius

THE MAXIMUM PERMISSIBLE EXPOSURE (MPE) RADIUS HAS BEEN ESTIMATED TO BE A RADIUS OF ABOUT 3M PER OET BULLETIN 65 OF THE FCC. THIS ESTIMATE IS MADE ASSUMING THE MAXIMUM POWER OF THE RADIO AND ANTENNAS WITH A MAXIMUM GAIN OF 9dBi ARE USED FOR A SHIP MOUNTED SYSTEM.

TABLE OF CONTENTS

FOREWORD	i	■ Position and time programming	18	11 CHANNEL LIST	55
IMPORTANT	i	■ Position indication	19	12 SPECIFICATIONS AND	
IN CASE OF EMERGENCY	ii	■ Distress call	20	OPTIONS	56–57
NOTE	ii	■ Transmitting DSC calls	22	■ Specifications	56
RADIO OPERATOR WARNING	iii	■ Setting the distress information	30	■ Options	57
TABLE OF CONTENTS	iv	■ DSC individual ID	31	13 HM-127 REMOTE-CONTROL	
PRECAUTION	v	■ Receiving DSC calls	34	MICROPHONE	58–70
1 OPERATING RULES	1	■ DSC set mode	36	■ Panel description	58
2 PANEL DESCRIPTION	2–7	■ Received messages	38	■ Function display	60
■ Panel description	2	7 OTHER FUNCTIONS	40–46	■ HM-127 supplied accessories	61
■ Function display	6	■ Intercom operation	40	■ Installation	62
■ Microphone (HM-136)	7	■ Hailer operation	41	■ Channel selection	64
3 BASIC OPERATION	8–13	■ Automatic fog horn	42	■ Receiving and transmitting	65
■ Channel selection	8	■ Microphone lock function	43	■ RF attenuator function	65
■ Receiving and transmitting	10	8 SET MODE	44–47	■ Lock functions	66
■ Call channel programming	11	■ Set mode programming	44	■ Display backlighting	66
■ Channel comments	11	■ Set mode items	45	■ Monitor function	66
■ Optional voice scrambler operation ...	13	9 CONNECTIONS AND		■ Call channel programming	67
4 DUALWATCH/TRI-WATCH ...	14–15	MAINTENANCE	48–53	■ Optional voice scrambler operation ...	67
■ Description	14	■ Supplied accessories	48	■ Starting a scan	68
■ Operation	15	■ Antenna	48	■ Setting tag channels	68
5 SCAN OPERATIONS	16–17	■ Fuse replacement	48	■ Dualwatch/Tri-watch operation	68
■ Scan types	16	■ Cleaning	48	■ Set mode programming	69
■ Setting tag channels	17	■ Connections	49	■ Intercom operation	70
■ Starting a scan	17	■ Mounting the transceiver	50	■ Channel comments	70
6 DSC OPERATION	18–39	■ Optional unit installation	52	TEMPLATE	
■ MMSI code programming	18	■ Dimensions	53		
		10 TROUBLESHOOTING	54		

1**2****3****4****5****6****7****8****9****10****11****12****13**

PRECAUTION

⚠ WARNING! NEVER connect the transceiver to an AC outlet. This may pose a fire hazard or result in an electric shock.

CAUTION: Changes or modifications to this device, not expressly approved by Icom Inc., could void your authority to operate this device under FCC regulations.

NEVER connect the transceiver to a power source of more than 16 V DC or use reverse polarity. This will ruin the transceiver.

NEVER cut the DC power cable between the DC plug and fuse holder. If an incorrect connection is made after cutting, the transceiver may be damaged.

NEVER place the transceiver where normal operation of the vessel may be hindered or where it could cause bodily injury.

KEEP the transceiver at least 3.3 ft (1 m) away from the ship's navigation compass.

DO NOT use or place the transceiver in areas with temperatures below -4°F (-20°C) or above $+140^{\circ}\text{F}$ ($+60^{\circ}\text{C}$) or, in areas subject to direct sunlight, such as the dashboard.

AVOID the use of chemical agents such as benzine or alcohol when cleaning, as they may damage the transceiver surfaces.

BE CAREFUL! The transceiver rear panel will become hot when operating continuously for long periods.

Place the transceiver in a secure place to avoid inadvertent use by children.

BE CAREFUL! The transceiver and optional HM-127 employ waterproof construction, which corresponds to JIS waterproof specification, Grade 7 (1 m/30 min.). However, once the transceiver or microphone has been dropped, waterproofing cannot be guaranteed due to the fact that the case may be cracked, or the waterproof seal damaged, etc.

EXPLICIT DEFINITIONS

WORD	DEFINITION
⚠ WARNING	Personal injury, fire hazard or electric shock may occur.
CAUTION	Equipment damage may occur.
NOTE	If disregarded, inconvenience only. No risk or personal injury, fire or electric shock.

◇ PRIORITIES

- Read all rules and regulations pertaining to priorities and keep an up-to-date copy handy. Safety and distress calls take priority over all others.
- You must monitor Channel 16 when you are not operating on another channel.
- False or fraudulent distress signals are prohibited and punishable by law.

◇ PRIVACY

- Information overheard but not intended for you cannot lawfully be used in any way.
- Indecent or profane language is prohibited.

◇ RADIO LICENSES

(1) SHIP STATION LICENSE

You must have a current radio station license before using the transceiver. It is unlawful to operate a ship station which is not licensed.

Inquire through your dealer or the appropriate government agency for a Ship-Radiotelephone license application. This government-issued license states the call sign which is your craft's identification for radio purposes.

(2) OPERATOR'S LICENSE

A Restricted Radiotelephone Operator Permit is the license most often held by small vessel radio operators when a radio is not required for safety purposes.

The Restricted Radiotelephone Operator Permit must be posted or kept with the operator. Only a licensed radio operator may operate a transceiver.

However, non-licensed individuals may talk over a transceiver if a licensed operator starts, supervises, ends the call and makes the necessary log entries.

Keep a copy of the current government rules and regulations handy.

Radio license for boaters (U.S.A. only)

The Telecommunications Act of 1996 permits recreational boaters to have and use a VHF marine radio, EPIRB, and marine radar without having an FCC ship station license. Boaters traveling on international voyages, having an HF single sideband radiotelephone or marine satellite terminal, or required to carry a marine radio under any other regulation must still carry an FCC ship station license. For further information, see the FCC Ship Radio Stations Fact Sheet.

2

PANEL DESCRIPTION

■ Panel description

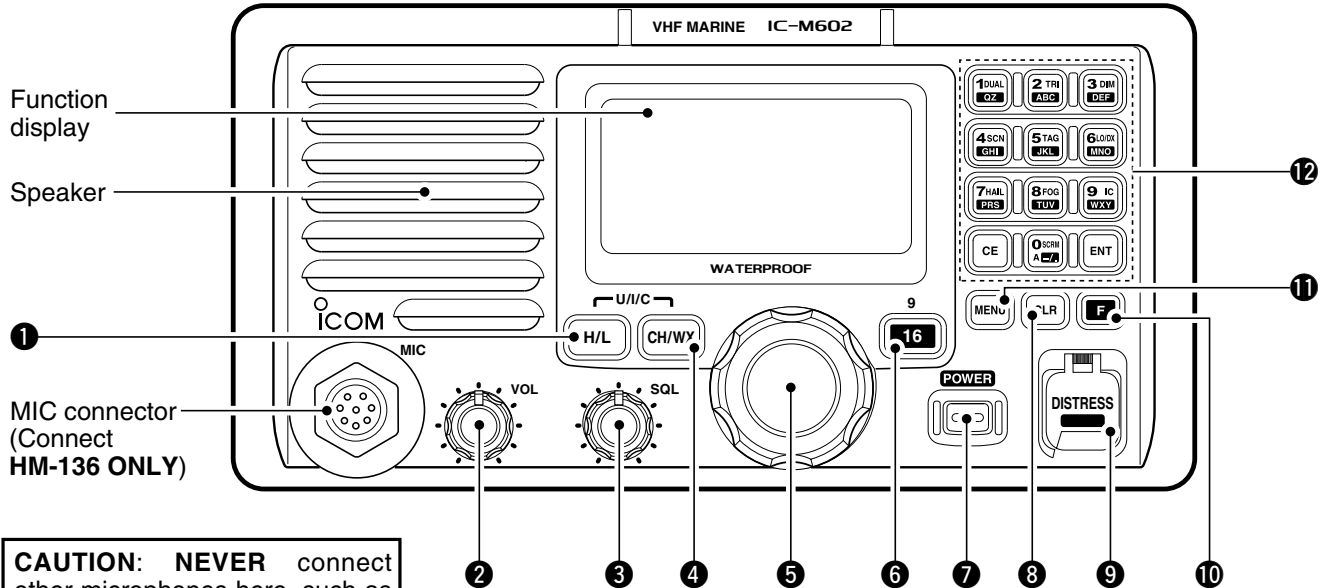

CAUTION: NEVER connect other microphones here, such as the optional HM-127, may cause damage to the transceiver.

❶ TRANSMIT POWER SWITCH [H/L]

- ➔ Toggles high or low power when pushed. (p. 10)
 - Some channels are set to low power only.
- ➔ While pushing this switch, some switches perform secondary functions.

❷ VOLUME CONTROL [VOL] (P. 10)

Adjusts the audio level.

❸ SQUELCH CONTROL [SQL] (P. 10)

Sets the squelch threshold level.

❹ CHANNEL SWITCH [CH/WX•U//C] (p. 9)

- ➔ Selects and toggles the regular channels or weather channel when pushed momentarily.
- ➔ While pushing [H/L], push to select one of 3 regular channels in sequence.
 - International, U.S.A. and Canadian channels are available for regular channels.

❺ CHANNEL SELECTOR [CHANNEL] (p. 10)

Rotate [CHANNEL] to select the operating channels, set mode contents, etc.

❻ CHANNEL 16/CALL CHANNEL SWITCH [16•9]

- ➔ Selects Channel 16 when pushed. (p. 8)
- ➔ Selects call channel when pushed for 1 sec. (p. 8)
 - "CALL" appears when call channel is selected.
- ➔ Push for 3 sec. to enter call channel programming condition when call channel is selected. (p. 11)
- ➔ While pushing [H/L], enters memory name programming condition. (p. 11)
- ➔ While turning power ON, enters set mode when pushed and held. (p. 44)

❼ POWER SWITCH [POWER]

Push to turn the transceiver power ON or OFF.

❽ CLEAR SWITCH [CLR]

Push to cancel the entered function.

❾ DISTRESS SWITCH [DISTRESS] (p. 20)

Transmits distress call when pushed for 5 sec.

❿ FUNCTION SWITCH [F]

After pushing, activates the secondary functions.

- "F" appears when a secondary function can be accessed.

⓫ DSC MENU SWITCH [MENU] (P. 18)

- ➔ Toggles the DSC menu ON or OFF when pushed.

2 PANEL DESCRIPTION

12 KEYPAD

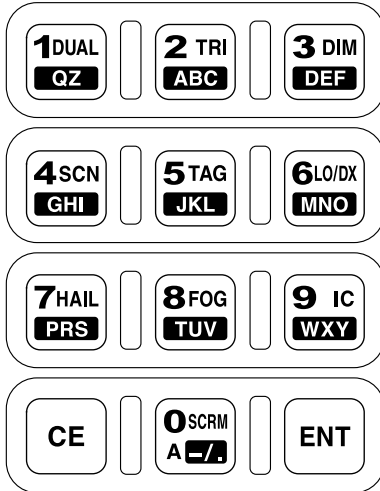

1 DUAL
QZ

- Inputs the numeral “1” for channel number input, etc.
- Inputs “1,” “Q,” “Z,” “q,” “z” or space for channel comment input.
- After pushing **[F]**, turns the dualwatch function ON or OFF. (p. 15)

2 TRI
ABC

- Inputs the numeral “2” for channel number input, etc.
- Inputs “2,” “A,” “B,” “C” “a,” “b” or “c” for channel comment input.
- After pushing **[F]**, turns the tri-watch function ON or OFF. (p. 15)

3 DIM
DEF

- Inputs the numeral “3” for channel number input, etc.
- Inputs “3,” “D,” “E,” “F,” “d,” “e” or “f” for channel comment input.
- After pushing **[F]**, push this switch and rotate [CHANNEL] to adjust the brightness of the LCD and switch backlight.

4 SCN
GHI

- Inputs the numeral “4” for channel number input, etc.
- Inputs “4,” “G,” “H,” “I,” “g,” “h” or “i” for channel comment input.
- After pushing **[F]**, starts or stops the scan function. (p. 17)



- Inputs the numeral “5” for channel number input, etc.
- Inputs “5,” “J,” “K,” “L,” “j,” “k” or “l” for channel comment input.
- After pushing [F], sets the displayed channel as a tag (scanned) channel. (p.17)
- While pushing [H/L], push for 3 sec. to clear all tag channels. (p.17)



- Inputs the numeral “6” for channel number input, etc.
- Inputs “6,” “M,” “N,” “O,” “m,” “n” or “o” for channel comment input.
- After pushing [F], turns the attenuator function ON or OFF. (p. 10)
 - “LOCAL” appears when the attenuator is in use.



- Inputs the numeral “7” for channel number input, etc.
- Inputs “7,” “P,” “R,” “S,” “p,” “r” or “s” for channel comment input.
- After pushing [F], turns the hailer function ON or OFF. (p. 41)



- Inputs the numeral “8” for channel number input, etc.
- Inputs “8,” “T,” “U,” “V,” “t,” “u” or “v” for channel comment input.
- After pushing [F], turns the auto fog horn function ON or OFF. (p. 43)



- Inputs the numeral “9” for channel number input, etc.
- Inputs “9,” “W,” “X,” “Y,” “w,” “x” or “y” for channel comment input.
- After pushing [F], turns the intercom function ON or OFF. (p. 40)



- Inputs the numeral “0” for channel number input, etc.
- Push for 1 sec. to edit “A” channel for channel number input.
- Inputs “0” and symbols (“_” “/” “.”) for channel comment input.
- After pushing [F], activates an optional voice scrambler function. (p. 13)
 - The optional voice scrambler function cannot be used on Channel 16 and 70.



- Fixes input of channel number and channel comment, etc.



- Clears entered digits and retrieves the previous frequency, channel or channel names during setting.

2 PANEL DESCRIPTION

■ Function display

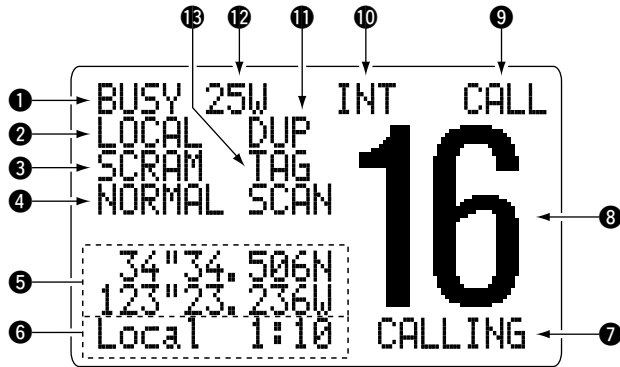

- 1 BUSY/TRANSMIT INDICATOR** (p. 10)
 - "BUSY" appears when receiving a signal or when the squelch opens.
 - "TX" appears while transmitting.
- 2 RECEIVER ATTENUATOR INDICATOR** (p. 10)

"LOCAL" appears when the receiver attenuator is in use.
- 3 SCRAMBLER INDICATOR** (p. 13)

"SCRAM" appears when an optional voice scrambler is activated.

4 SCAN INDICATOR

- Either "NORMAL SCAN" or "PRI-SCAN 16" scan type appears while scanning. (p. 17)
- "DUAL 16" appears during dualwatch; "TRI 16" appears during tri-watch. (p. 15)

5 POSITION INDICATOR

- Shows the GPS position data.
 - "??" may blink every 2 sec. instead of position data when the GPS position data is invalid. In such a case, the last position data is held for up to 23.5 hours.
 - "??" may blink every 2 sec. instead of position data 4 hours after the position data is input manually, up until 23.5 hours have past.
- "No Position" appears when no GPS receiver is connected and no position data is input manually.

6 TIME ZONE INDICATOR

- "Local" appears when the offset time data in the 'Set up' menu is entered. (p. 36)
- "No Time" appears when no GPS receiver is connected and no time data is input manually.

7 CHANNEL COMMENT INDICATOR

- Channel comment appears if programmed. (p. 11)
- "Low Batt" flashes when the battery voltage drops to approx. 10 V DC or below.

8 CHANNEL NUMBER READOUT

- Indicates the selected operating channel number.
 - “A” appears when a simplex channel is selected. (p. 9)
 - “b” appears when a receive only channel for a Canadian channel group is selected.
- “F” appears when [F] switch is pushed.

9 CALL CHANNEL INDICATOR (p. 8)

“CALL” appears when the call channel is selected.

10 CHANNEL GROUP INDICATOR (p. 9)

Indicates whether an International “INT,” U.S.A. “USA,” Canadian “CAN” or weather “WX” channel is selected.

11 DUPLEX INDICATOR (p. 9)

Appears when a duplex channel is selected.

12 POWER INDICATOR (p. 10)

- “25W” appears when high power is selected.
- “1W” appears when low power is selected.

13 TAG CHANNEL INDICATOR (p. 17)

Appears when a tag channel is selected.

Microphone (HM-136)

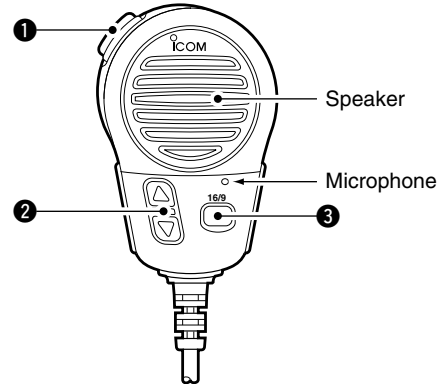

1 PTT SWITCH [PTT] (p. 10)

Push and hold to transmit; release to receive.

2 CHANNEL UP/DOWN SWITCHES [▲]/[▼] (P. 10)

Push either switch to change the operating channel, set mode contents, etc.

3 CHANNEL 16/CALL CHANNEL SWITCH [16/9]

- Push to select Channel 16; push for 1 sec. to Channel 9. (p. 8)
- While pushing [16/9], turn power ON to toggle the lock function ON or OFF. (p. 43)

■ Channel selection

◇ Channel 16

Channel 16 is the distress and safety channel. It is used for establishing initial contact with another station and for emergency communications. Channel 16 is monitored during both dualwatch and tri-watch. While standing by, you must monitor Channel 16.

- ➔ Push [16•9] momentarily to select Channel 16.
- ➔ Push [CH/WX•U/I/C] to return to the condition before selecting Channel 16, or rotate [CHANNEL] to select operating channel.

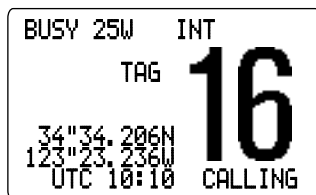

◇ Channel 9 (Call channel)

Each regular channel group has a separate leisure-use call channel. The call channel is monitored during tri-watch. The call channels can be programmed (p. 11) and are used to store your most often used channels in each channel group for quick recall.

- ➔ Push [16•9] for 1 sec. to select the call channel of the selected channel group.
 - "CALL" and call channel number appear.
 - Each channel group may have an independent call channel after programming a call channel.
- ➔ Push [CH/WX•U/I/C] to return to the condition before selecting the call channel, or rotate [CHANNEL] to select an operating channel.

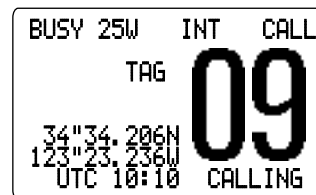
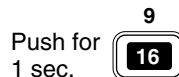

◆ U.S.A., Canadian and International channels

There are 57 U.S.A., 61 Canadian and 57 International channels. These channel groups may be specified for the operating area.

- ① Push [CH/WX•U/I/C] to select a regular channel.
 - If a weather channel appears, push [CH/WX•U/I/C] again.
- ② While pushing [H/L], push [CH/WX•U/I/C] to change the channel group, if necessary.
 - U.S.A., International (INT) and Canadian channels can be selected in sequence.
- ③ Rotate [CHANNEL] to select a channel.
 - “DUP” appears for duplex channels.
 - “A” appears for simplex channels.

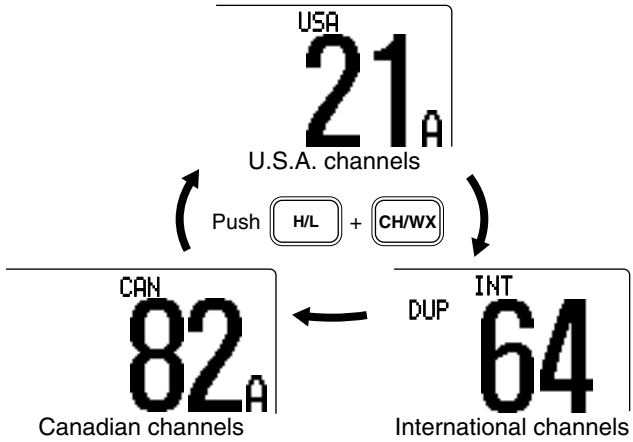

◆ Weather channels

There are 10 weather channels. Used for monitoring weather channels from the NOAA (National Oceanographic and Atmospheric Administration) broadcasts.

The transceiver can detect a weather alert tone on the selected weather channel while receiving that channel, during standby on a regular channel or while scanning. See “Weather alert” on p. 45.

- ① Push [CH/WX•U/I/C] once or twice to select a weather channel.
 - “WX” appears when a weather channel is selected.
 - “WX ALERT” appears when the weather alert function is in use. (p. 45)

Push once or twice



When weather alert is OFF.

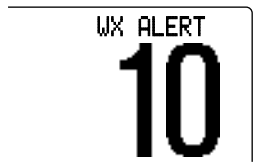

When weather alert is ON.

- ② Rotate [CHANNEL] to select a channel.

3 BASIC OPERATION

■ Receiving and transmitting

CAUTION: Transmitting without an antenna may damage the transceiver.

- ① Push [POWER] to turn power ON.
- ② Set the audio and squelch levels.
 - ➔ Rotate [SQL] fully counterclockwise in advance.
 - ➔ Rotate [VOL] to adjust the audio output level.
 - ➔ Rotate [SQL] clockwise until the noise disappears.
- ③ To change the channel group, push [CH/WX•U/I/C] while pushing [H/L]. (p. 9)
- ④ Rotate [CHANNEL] or push [▲]/[▼] on the microphone to select the desired channel.
 - When receiving a signal, “BUSY” appears and audio is emitted from the speaker.
 - Further adjustment of [VOL] may be necessary at this point.
 - Use the optional voice scrambler function for privacy. (p. 13)
- ⑤ Push [F], then push [6 LO/DX] to turn the receive attenuator function ON or OFF if necessary.
 - “LOCAL” appears when the receive attenuator is in use.
- ⑥ Push [H/L] to select the output power if necessary.
 - “25W” or “1W” appears when high or low power is selected, respectively.
 - Choose low power to conserve power, choose high power for longer distance communications.
 - Some channels are for low power only.

- ⑦ Push and hold [PTT] to transmit, then speak into the microphone.
 - “T” appears.
 - Channel 70 cannot be used for transmission.

Simplex channels, 3, 21, 23, 61, 64, 81, 82 and 83 **CANNOT** be lawfully used by the general public in U.S.A. waters.

- ⑧ Release [PTT] to receive.

IMPORTANT: To maximize the readability of your transmitted signal, pause a few sec. after pushing [PTT], hold the microphone 1 to 2 inches (2.5 to 5 cm) from your mouth and speak at a normal voice level.

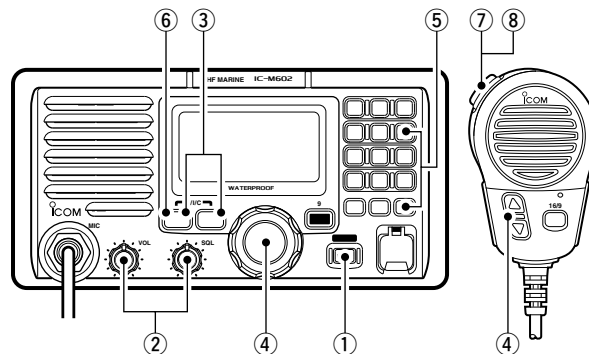

Call channel programming

The call channel is used to select Channel 9, however, you can program your most often-used channels in each channel group for quick recall.

- ① While pushing [H/L], push [CH/WX•U/I/C] one or more times to select the desired channel group (U.S.A., International, Canada) to be programmed.
- ② Push [16•9] for 1 sec. to select the call channel of the selected channel group.
 - “CALL” and call channel number appear.
- ③ Push [16•9] again for 3 sec. (until a long beep changes to 2 short beeps) to enter call channel programming condition.
 - Channel number starts blinking.
- ④ Rotate [CHANNEL] to select the desired channel.
- ⑤ Push [16•9] to program the displayed channel as the call channel.
 - Push [CH/WX•U/I/C] to cancel.
 - The channel number stops blinking.

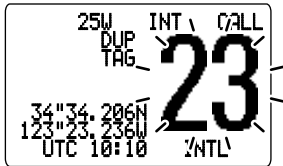
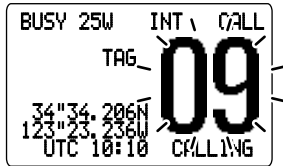

Channel comments

Memory channels can be tagged with alphanumeric names of up to 10 characters each.

Capital letters, small letters, numerals, some symbols (— . /) and space can be used.



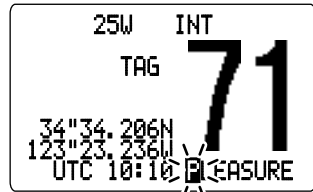







- ① Select the desired memory channel.
 - Cancel dual watch, tri-watch or scan in advance.
- ② While pushing [H/L], push [16•9] to edit the channel comment.
 - A cursor appears and blinks.



- ③ Push the appropriate key several times to enter the desired character.
 - See the table on page 12 for available characters.
 - Rotate [CHANNEL] or push [▲]/[▼] on the microphone to move the cursor.
- ④ Push [ENT] to input and set the comment.
 - Push [CLR] to cancel.
 - The cursor disappears.
- ⑤ Repeat steps ① to ④ to program other channel comments, if desired.

3 BASIC OPERATION

•Available characters

KEY	CHARACTERS	KEY	CHARACTERS
	1 Q Z q z (space)		6 M N O m n o
	2 A B C a b c		7 P R S p r s
	3 D E F d e f		8 T U V t u v
	4 G H I g h i		9 W X Y w x y
	5 J K L j k l		0 - / .

Optional voice scrambler operation

◆ Activating the scrambler

The optional voice scrambler provides private communications. In order to receive or send scrambled transmissions you must first activate the scrambler function. To activate the function, an optional UT-112 is necessary. See p. 47 for setting the scrambler unit. Ask your dealer for details.

/// The scrambler function automatically turns OFF when Channel 16 or 70 is selected.

- ① Select an operating channel other than Channel 16 and 70.
- ② Push [F], then push [0 SCRM] to turn the optional scrambler function ON.
 - "SCRAM" appears.
- ③ To turn the scrambler function OFF, repeat step ②.
 - "SCRAM" disappears.

◆ Programming scrambler codes

There are 32 codes (1 to 32) available for programming when the optional UT-112 is installed. In order to understand one another, all transceivers in your group must have the same scramble code. This function may not be available depending on dealer setting.

- ① Turn power OFF.
- ② While pushing [16•9], turn power ON to enter set mode.
- ③ After the display appears, release [16•9].
- ④ Rotate [CHANNEL] to select the "Scrambler Code," push [ENT].
- ⑤ Rotate [CHANNEL] to select the desired scrambler code.
- ⑥ Push [ENT] to set and exit the scrambler code item.
- ⑦ Rotate [CHANNEL] to select "Exit," then push [ENT] to exit set mode.

[Example]: Programming scrambler code 8.

```

  9
  [16] + [POWER]
  Enter set mode

  --Set Mode--
  →Scan Type
  Scan Timer
  WX Alert
  Dual/Tri COMMANDMIC
  Beep
  Internal Speaker
  Contrast

  Select item
  → then push
  [ENT]

  --Set Mode--
  Internal Speaker
  Contrast
  RF Attenuator
  Foghorn Frequency
  Scrambler Type
  →Scrambler Code
  Exit

  Select code
  → then push
  [ENT]

  --Set Mode--
  Scrambler Code
  9
  →8
  7
  6
  5
  <ENT→OK>
  
```

4

DUAL WATCH/TRI-WATCH

■ Description

Dualwatch monitors Channel 16 while you are receiving another channel; tri-watch monitors Channel 16 and the call channel while receiving another channel.

DUALWATCH/TRI-WATCH SIMULATION

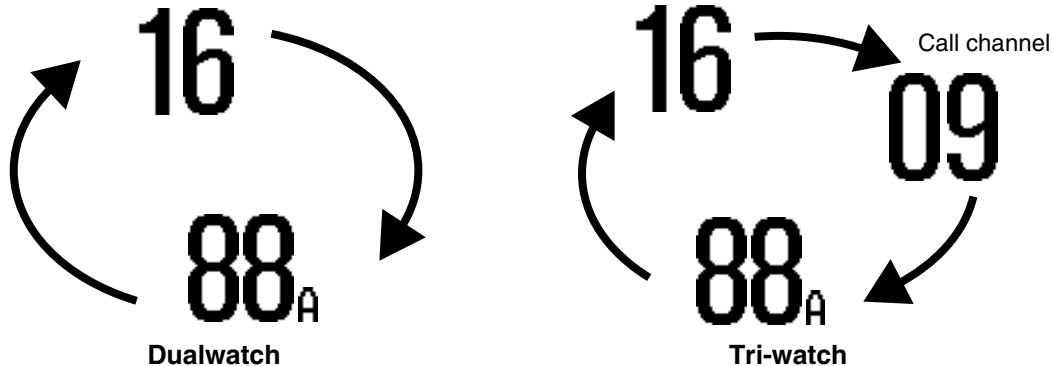

- If a signal is received on Channel 16, dualwatch/tri-watch pauses on Channel 16 until the signal disappears.
- If a signal is received on the call channel during tri-watch, tri-watch becomes dualwatch until the signal disappears.
- To transmit on the selected channel during dualwatch/tri-watch, push and hold [PTT].

■ Operation

- ① Select the desired operating channel.
- ② Push [F], then push [1 DUAL] to start dualwatch or [2 TRI] to start tri-watch.
 - “DUAL” appears during dualwatch; “TRI” appears during tri-watch.
 - A beep tone sounds when a signal is received on Channel 16.
- ③ To cancel dualwatch or tri-watch, push [CLR] or repeat step ②.

[Example]: Operating dualwatch on INT Channel 25.

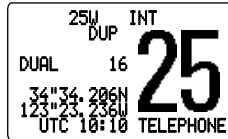

Tri-watch starts.

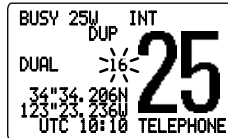

Signal received on Channel 16 takes priority.

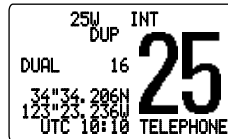

Dualwatch resumes after the signal disappears.

[Example]: Operating tri-watch on INT Channel 25.

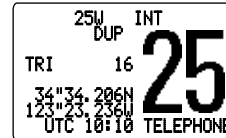

Tri-watch starts.



Signal is received on call channel.

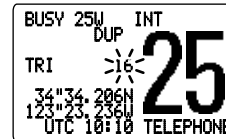

Signal received on Channel 16 takes priority.

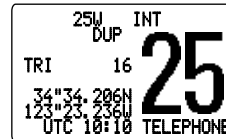

Tri-watch resumes after the signal disappears.

■ Scan types

Scanning is an efficient way to locate signals quickly over a wide frequency range. The transceiver has priority scan and normal scan.

When the weather alert function is in use, the selected weather channel is checked while scanning. (p. 45)

Set the tag channels (scanned channel) before scanning. Clear the tag channels which inconveniently stop scanning, such as those for digital communication use.

☞ Choose priority or normal scan in set mode. (p. 45)

PRIORITY SCAN

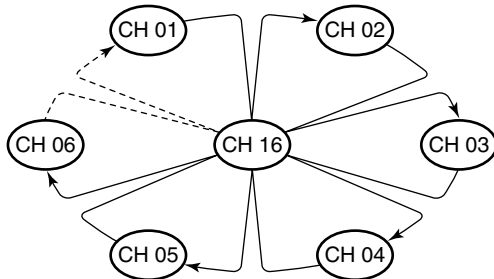

Priority scan searches through all tag channels in sequence while monitoring Channel 16. When a signal is detected on Channel 16, scan pauses until the signal disappears; when a signal is detected on a channel other than Channel 16, scan becomes dualwatch until the signal disappears.

NORMAL SCAN

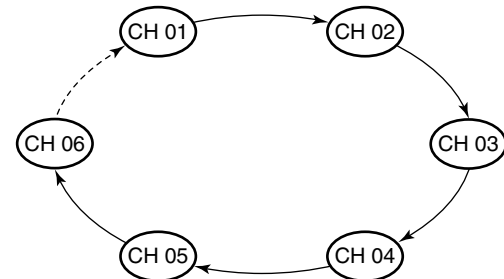

Normal scan, like priority scan, searches through all tag channels in sequence. However, unlike priority scan, Channel 16 is not checked unless Channel 16 is set as a tag channel.

■ Setting tag channels

For more efficient scanning, add desired channels as tag channels or clear tag channels for unwanted channels. Channels set as non-tag channels will be skipped during scanning. Tag channels can be assigned to each channel group (U.S.A., International, Canada) independently.

- ① While pushing [H/L], push [CH/WX•U/I/C] one or more times to select the desired channel group, if desired.
- ② Select the desired channel to set as a tag channel.
- ③ Push [F], then push [5 TAG] to set the displayed channel as a tag channel.
 - “TAG” appears in the display.
- ④ To cancel the tag channel setting, repeat step ③.
 - “TAG” disappears.

• Clearing all tag channels in the selected channel group

- While pushing [H/L], push [5 TAG] for 3 sec. to clear all tag channels in the channel group.

■ Starting a scan

Set scan type (priority or normal scan) and scan resume timer in advance using set mode. (p. 45)

- ① Set tag channels as described at left.
- ② Make sure the squelch is closed to start a scan.
- ③ While pushing [H/L], push [CH/WX•U/I/C] one or more times to select the desired channel group, if desired.
- ④ Push [F], then push [4 SCN] to start priority or normal scan.
 - “PRI-SCAN 16” or “NORMAL SCAN” appears in the function display.
 - When a signal is detected, scan pauses until the signal disappears or resumes after pausing 5 sec. according to set mode setting. (Channel 16 is still monitored during priority scan.)
 - Rotate [CHANNEL] to check the scanning tag channels, to change the scanning direction or resume the scan manually.
 - “16” blinks and a beep tone sounds when a signal is received on Channel 16 during priority scan.
- ⑤ To stop the scan, push [CLR] or repeat step ④.

[Example]: Starting a normal scan.

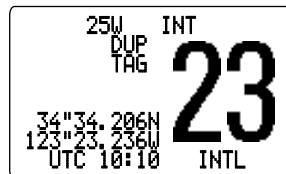

Scan starts.

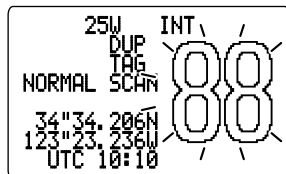

When a signal is received

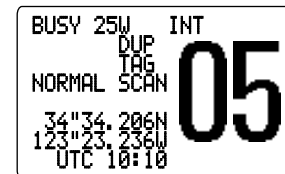

■ MMSI code programming

The 9-digit MMSI (Maritime Mobile Service Identity: DSC self ID) code can be programmed at power ON.

/// **This code programming can be performed only twice.**

- ① Turn power OFF.
- ② While pushing [MENU], turn power ON to enter MMSI code programming condition.
- ③ After the display appears, release [MENU].
- ④ Push [MENU] to enter the DSC menu.
- ⑤ Rotate [CHANNEL] to select "Set up," push [ENT].
- ⑥ Rotate [CHANNEL] to select "MMSI check," push [ENT].



- ⑦ Edit the specific MMSI code directly with the keypad.
 - Rotate [CHANNEL] to move the cursor backward or forward.
- ⑧ Input the 9 digit code, then push [ENT] to set the code.
 - Returns to the DSC set up menu.
- ⑨ Rotate [CHANNEL] to select "Exit," push [ENT].
 - Returns to the DSC menu.
 - Repeat again to return to the normal operation condition.

■ Position and time programming

A distress call should include the ship's position and time. If no GPS is connected, your position and UTC (Universal Time Coordinated) time should be input. They are included automatically when a GPS receiver (NMEA0183 ver. 2.0) is connected.

/// This manual programming is not available when a GPS receiver (NMEA0183 ver. 2.0) is connected.

- ① Push [MENU] to enter the DSC menu.
- ② Rotate [CHANNEL] to select "Position Input," push [ENT].

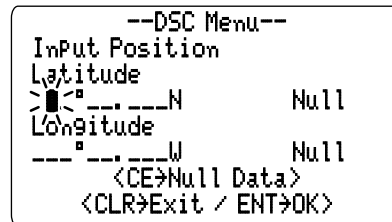

- ③ Edit the digit of your latitude data directly with the keypad.
 - Push [6•MNO] to edit N; North latitude or [7•PRS] to edit S; South latitude.
 - Rotate [CHANNEL] to move the cursor backward or forward.
 - Push [CE] to clear the position data.

- ④ Edit the digit of your longitude data directly with the keypad.
- Push [3•DEF] to edit E; East longitude or [9•WXY] to edit W; West longitude.
 - Rotate [CHANNEL] to move the cursor backward or forward.
 - Push [CE] to clear the position data.
- ⑤ Push [ENT] to set the position and advance to the time setting condition.
- Push [CLR] to abandon the setting and exit the condition.

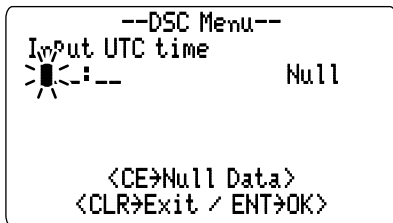

- ⑥ Edit the digit of the current UTC time directly with the keypad.
- Rotate [CHANNEL] to move the cursor backward or forward.
 - Push [CE] to clear the time.
- ⑦ Push [ENT] to set the time.
- Push [CLR] to abandon the setting and exit the condition.

■ Position indication

When a GPS receiver (NMEA0183 ver. 2.0) is connected, the transceiver displays the current position and time. When no GPS receiver is connected, the transceiver displays the manually entered position and time.

A GPS receiver appropriate for the IC-M602 is not supplied from Icom. A GPS receiver with NMEA0183 ver. 2.0 format is required for position indication. Ask your dealer about suitable GPS receivers.

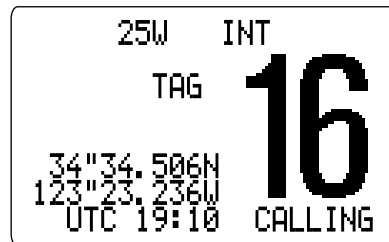

6 DSC OPERATION

■ Distress call

A distress call should be transmitted, if in the opinion of the Master, the ship or a person is in distress and requires immediate assistance.

NEVER USE THE DISTRESS CALL WHEN YOUR SHIP IS NOT IN AN EMERGENCY. A DISTRESS CALL CAN BE USED ONLY WHEN IMMEDIATE HELP IS NEEDED.

- ① Confirm no distress call is being received.
- ② While lifting up the switch cover, push [DISTRESS] for 5 sec. to transmit the distress call.
 - An emergency channel (Ch 70) is automatically selected and the distress call is transmitted.
 - When no GPS is connected, input your position and UTC time, if possible.

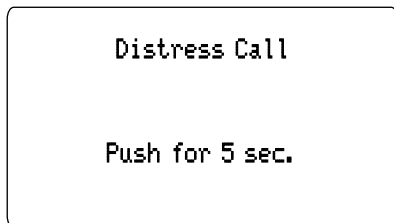

- ③ After transmitting the call, the transceiver waits for an acknowledgment call on Ch 70.
 - The distress call is automatically transmitted every 3.5 to 4.5 minutes.

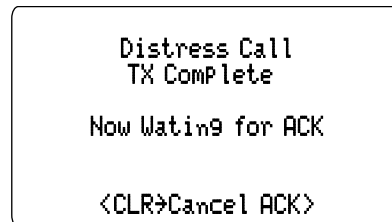

- ④ After 5 sec., the transceiver is set to Channel 16 automatically.

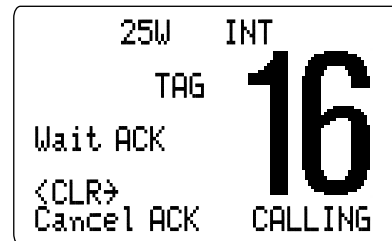

- ⑤ When receiving the acknowledgment, reply using the microphone.

```

      25W   INT
      TAG
Received TAG
DistressACK 16
<Osaka Bay
>Chuck3
<CLR>Exit> CALLING
  
```

- A distress alert contains (default);
 - Kind of distress : Undesignated distress
 - Position data : GPS or manual input position data held for 23.5 hrs.
- The distress call is repeated every 3.5–4.5 min., until receiving an 'acknowledgement.'
- Push [DISTRESS] to transmit a renewed distress call, if required.
- Push [CLR] to cancel the 'Call repeat' mode.
- "??" may blink instead of position and time indications when the GPS data is invalid, or has not been updated after 4 hours the position and time data input manually.

■ Transmitting DSC calls

◆ Transmitting Individual call

The individual call function allows you to transmit a DSC signal to a specific ship only.

- ① Push [MENU] to enter the DSC menu.
- ② Rotate [CHANNEL] to select "Individual Call," push [ENT].

```
      --DSC Menu--  
Select item  
→Individual Call  
  Group Call  
  All Ships Call  
  Position Request  
  Polling Request  
  Received Calls
```

- ③ Rotate [CHANNEL] to select the desired pre-programmed individual address or "Manual InPut," push [ENT].
 - The ID code for the individual call can be set in advance. (p. 31)
 - When "Manual InPut" is selected, set the 9-digit ID code for the individual you wish to call with the keypad.

```
      --DSC Menu--  
Select Address  
  Manual InPut  
  John  
  Margaret  
  →Ricky  
  
      <CLR→Exit / ENT→OK>
```

- ④ Rotate [CHANNEL] to select a desired intership channel or "Manual InPut," push [ENT].
 - When "Manual InPut" is selected, rotate [CHANNEL] to select the desired channel other than Channel 70.

```
      --DSC Menu--  
Select Intership CH  
→08  
  69  
  77  
  06  
  
      <CLR→Exit / ENT→OK>
```

- ⑤ Push [ENT] to transmit the individual call.
- If Channel 70 is busy, the transceiver stands by until the channel becomes clear.

<pre>--DSC Menu-- Individual Call Ready <CLR>Exit / ENT>OK></pre>	<pre>--DSC Menu-- Individual Call CH70 BUSY <CLR>Exit></pre>
--	---

Push [ENT] to transmit DSC call. When Ch 70 is busy.

- ⑥ Standby on Channel 70 until an acknowledgement is received.

```
--DSC Menu--
Individual Call
TX Complete

Now Waiting for ACK

<CLR>Exit>
```

- ⑦ When the acknowledgement is received, the display changes to the previously selected channel with beeps.
- ⑧ Push and hold [PTT] to communicate your message to the responding ship.

◆ Transmitting Individual acknowledgement

Transmit an acknowledgement ('able to comply' or 'unable to comply') when an individual call for you is received.

- ① Push [MENU] to enter the DSC menu.
- ② Rotate [CHANNEL] to select "Individual ACK," push [ENT].
 - "Individual ACK" item appears after an individual call is received.

```
--DSC Menu--
Select item
Individual Call
>Individual ACK
Group Call
All Ships Call
Position Request
Polling Request
```

- ③ Rotate [CHANNEL] to select the desired individual address or ID code, push [ENT].

```
--DSC Menu--
Select Address
Manual InPut
John
Margaret
>Ricky

<CLR>Exit / ENT>OK>
```

6 DSC OPERATION

- ④ Rotate [CHANNEL] to select an acknowledgement "Able to Comply" or "Unable to Comply," push [ENT].

```
      --DSC Menu--  
Select Action  
→Able to Comply  
  Unable to Comply  
  
      <CLR>Exit / ENT→OK
```

- ⑤ If you select "Unable to Comply," select the reason by rotating [CHANNEL], push [ENT].

• 'No reason given,' 'Congestion,' 'Busy,' 'Queue indication,' 'Station Barred,' 'No operator,' 'Operator Unavailable,' 'Equipment Disable,' 'Channel Unavailable' and 'Mode Unavailable' are available.

```
      --DSC Menu--  
Select Reason  
  No Reason Given  
→Congestion  
  Busy  
  Queue Indication  
  Station Barred  
  No Operator  
  Operator Unavailable  
  Equipment Disable  
  Channel Unavailable  
  Mode Unavailable  
  
      <CLR>Exit / ENT→OK
```

- ⑥ Push [ENT] to transmit the acknowledgement to the selected station.

```
      --DSC Menu--  
Individual ACK Ready  
  
      <CLR>Exit / ENT→OK
```

- ⑦ After the individual acknowledgement has been transmitted, the following indication is displayed.

```
      --DSC Menu--  
Individual ACK  
TX Complete
```

- ⑧ Then the display changes to the channel specified by the calling station, automatically.

◆ Transmitting Group call

The Group call function allows you to transmit a DSC signal to a specific group only.

- ① Push [MENU] to enter the DSC menu.
- ② Rotate [CHANNEL] to select "Group Call," push [ENT].

```

--DSC Menu--
Select item
 Individual Call
 →Group Call
 All Ships Call
 Position Request
 Polling Request
 Received Calls
  
```

- ③ Rotate [CHANNEL] to select the desired pre-programmed group address or "Manual Input," push [ENT].
 - The ID code for the group call can be set in advance. (p. 33)
 - When "Manual Input" is selected, set the 8-digit ID code for the group you wish to call with keypad.

```

--DSC Menu--
Select Address
 Manual Input
 I-com
 Osaka
 →Tokyo

<CLR>Exit / <ENT>OK>
  
```

- ④ Rotate [CHANNEL] to select a desired intership channel or "Manual Input," push [ENT].
 - When "Manual Input" is selected, rotate [CHANNEL] to select the desired channel other than Channel 70.
- ⑤ Push [ENT] to transmit the group call.
 - If Channel 70 is busy, the transceiver stands by until the channel becomes clear.

```

--DSC Menu--
Group Call ready

<CLR>Exit / <ENT>OK>
  
```

- ⑥ After the group call has been transmitted, the following indication is displayed.

```

--DSC Menu--
Group Call
TX Complete

<CLR>Exit>
  
```

- ⑦ Push [CLR] to exit the condition.

6 DSC OPERATION

◆ Transmitting All ships call

Large ships use Channel 70 as their 'listening channel.' When you want to announce a message to these ships, use the 'all ships call' function.

- ① Push [MENU] to enter the DSC menu.
- ② Rotate [CHANNEL] to select "All Ships Call," push [ENT].

```
--DSC Menu--  
Select item  
Individual Call  
Group Call  
→All Ships Call  
Position Request  
Polling Request  
Received Calls
```

- ③ Rotate [CHANNEL] to select the desired category, push [ENT].
 - Output power of 'Routine' category is 1 W (low power) only.

```
--DSC Menu--  
Select Category  
→Routine  
Safety  
Urgency
```

- ④ Push [ENT] to transmit the all ships call.
 - Channel 70 is selected and the all ships call is transmitted.

```
--DSC Menu--  
All Ships Call Ready  
  
<CLR>Exit / <ENT>OK
```

- ⑤ After the all ships call has been transmitted, the following indication is displayed.

```
--DSC Menu--  
All Ships Call  
TX Complete  
  
<CLR>Exit
```

- ⑥ Push [CLR] to exit the condition.
 - Even if [CLR] hasn't been pushed, the display automatically changes to channel 16 after 5 sec. inactivity.

◆ Transmitting Position request call

Transmit a position request call when you want to know a specific ship's current position, etc.

- ① Push [MENU] to enter the DSC menu.
- ② Rotate [CHANNEL] to select "Position Request," push [ENT].

```

--DSC Menu--
Select item
Individual Call
Group Call
All Ships Call
→Position Request
Polling Request
Received Calls
  
```

- ③ Rotate [CHANNEL] to select the desired pre-programmed individual address or "Manual Input," push [ENT].
 - The ID code for the individual call can be set in advance. (p. 31)
 - When "Manual Input" is selected, set the 9-digit ID code for the individual you wish to call with the keypad.

```

--DSC Menu--
Select Address
Manual Input
John
Margaret
→Ricky

<CLR>Exit / ENT>OK>
  
```

- ④ Push [ENT] to transmit the position request call.

```

--DSC Menu--
Position Request Ready

<CLR>Exit / ENT>OK>
  
```

- ⑤ After the position request call has been transmitted, the following indication is displayed.

```

--DSC Menu--
Position Request
TX Complete

Now Waiting for ACK

<CLR>Exit>
  
```

- ⑥ Push [CLR] to exit the condition.
 - Even if [CLR] hasn't been pushed, the display automatically returns to the original indication after 5 sec. of inactivity.

6 DSC OPERATION

◆ Transmitting Position reply call

Transmit a position reply call when a position request call is received.

- ① When a position request call is received, the following indication is displayed.

```
25W INT
TAG
Received
POS REQ
<Chuck3
<CLR>Exit>
<ENT>RePl y>COMMERCIAL
08
```

- ② Push [ENT] to reply to the position request call; push [CLR] to ignore the position request call.

◆ Transmitting Polling request call

Transmit a polling request call when you want to know a specific ship is in the communication area, etc.

- ① Push [MENU] to enter the DSC menu.
- ② Rotate [CHANNEL] to select "Polling Request," push [ENT].

```
--DSC Menu--
Select item
Individual Call
Group Call
All Ships Call
Position Request
→Polling Request
Received Calls
```

- ③ Rotate [CHANNEL] to select the desired pre-programmed individual address or "Manual Input," push [ENT].
 - The ID code for the individual call can be set in advance. (p. 31)
 - When "Manual Input" is selected, set the 9-digit ID code for the individual you wish to call with the keypad.

```
--DSC Menu--
Select Address
Manual InPut
John
Margaret
→Ricky

<CLR>Exit / ENT→OK>
```

- ④ Push [ENT] to transmit the polling request call.

```

--DSC Menu--
Polling Request Ready

<CLR>Exit / <ENT>OK>

```

- ⑤ After the polling request call has been transmitted, the following indication is displayed

```

--DSC Menu--
Polling Request
TX Complete

Now Waiting for ACK

<CLR>Exit>

```

- ⑥ Push [CLR] to exit the condition.
- Even if [CLR] hasn't been pushed, the display automatically returns to the original indication after 5 sec. of inactivity.

◆ Transmitting Polling reply call

Transmit a polling reply call when a polling request call is received.

- ① When a polling request call is received, the following indication is displayed.

```

25W INT
TAG
Received
POLL REQ
<Chuck3
<CLR>Exit>
<ENT>Reply>COMMERCIAL
08

```

- ② Push [ENT] to reply to the polling request call; push [CLR] to ignore the polling request call.

6 DSC OPERATION

■ Setting the distress information

The nature of the distress call should be included in the distress call.

- ① Push [MENU] to enter the DSC menu.
- ② Rotate [CHANNEL] to select "Distress Setting," push [ENT].

```
      --DSC Menu--
Select item
  Position Request
  Polling Request
  Received Calls
  →Distress Setting
  Set up
  Exit
```

- ③ Rotate [CHANNEL] to select the nature of the distress, push [ENT].
 - 'Undesignated,' 'Explosion,' 'Flooding,' 'Collision,' 'Grounding,' 'Capsizing,' 'Sinking,' 'Adrift (Disable adrift),' 'Abandoning (Abandoning ship),' 'Piracy (Piracy attack)' and 'MOB (Man overboard)' are available.

```
      --DSC Menu--
Select Nature
  Undesignated
  →Explosion
  Flooding
  Collision
  Grounding
  Capsizing
  Sinking
  Adrift
  Abandoning
  Piracy
  MOB

  <CLR>Exit / ENT→OK>
```

- ④ The position information appears. Set the current position, then push [ENT].
 - Edit the digit of your position data directly with the keypad.
 - Push [6•**MNO**] to edit N; North latitude or [7•**PRS**] to edit S; South latitude.
 - Push [3•**DEF**] to edit E; East longitude or [9•**WXY**] to edit W; West longitude.
 - Rotate [CHANNEL] to move the cursor backward or forward.
 - Push [CE] to clear the position data.

```

--DSC Menu--
Input Position
Latitude
>|-----N      Null
Longitude
-----W      Null
      <CE>Null Data>
      <CLR>Exit / <ENT>OK>

```

⑤ The time information appears. Set the current UTC time, push [ENT].

- Edit the digit of the current UTC time directly with the keypad.
- Push [CLR] to abandon the setting and exit the condition to selecting the nature menu.
- Rotate [CHANNEL] to move the cursor backward or forward.
- Push [CE] to clear the time.
- The selected nature of the distress is stored for 10 minutes.

```

--DSC Menu--
Input UTC time
>|:--      Null

      <CE>Null Data>
      <CLR>Exit / <ENT>OK>

```

⑥ Push [DISTRESS] for 5 sec. to transmit the distress call.

■ DSC individual ID

A total of 100 DSC address IDs can be programmed and named with up to 10 characters.

◆ Programming Address ID

- ① Push [MENU] to enter the DSC menu.
- ② Rotate [CHANNEL] to select "Set up," push [ENT].

```

--DSC Menu--
Select item
Position Request
Polling Request
Received Calls
Distress Setting
>Set up
Exit

```

- ③ Rotate [CHANNEL] to select "Add: INDU ID," push [ENT].

```

--DSC Menu--
Set up
>Add:INDU ID
Add:Group ID
DEL:INDU ID
DEL:Group ID
Offset time
MMSI Check

```

6 DSC OPERATION

④ Set the individual ID and ID name.

- Edit the 9-digits of the appropriate distress ID directly with the keypad.
- Push keypad several times to edit the character.
- Rotate [CHANNEL] to move the cursor backward or forward.
- Push [CE] to clear the ID and name.
- Push [CLR] to cancel and exit the condition to DSC set up menu.

```
      --DSC Menu--
Add: Individual ID
Input 9 digits
  █
  █ -----
  █ Input name
  █ -----
```

⑤ Push [ENT] to program and exit the condition to DSC set up menu.

◆ Deleting address ID

- ① Push [MENU] to enter the DSC menu.
- ② Rotate [CHANNEL] to select "Set up," push [ENT].
- ③ Rotate [CHANNEL] to select "DEL: INDU ID," push [ENT].
 - When no address ID is programmed, the transceiver exits the condition automatically.

```
      --DSC Menu--
Set up
Add: INDU ID
Add: Group ID
→DEL: INDU ID
DEL: Group ID
Offset time
MMSI Check
```

④ Rotate [CHANNEL] to select the desired ID name for deleting.

```
      --DSC Menu--
Select ID
Turtle
→John
Margaret
Ricky

<CLR>Exit / ENT→OK>
```

⑤ Push [ENT] to delete the address ID and exit the condition.

◆ Programming Group ID

- ① Push [MENU] to enter the DSC menu.
- ② Rotate [CHANNEL] to select "Set up," push [ENT].

```

--DSC Menu--
Select item
Position Request
Polling Request
Received Calls
Distress Setting
→Set up
Exit
  
```

- ③ Rotate [CHANNEL] to select "Add: Group ID," push [ENT].

```

--DSC Menu--
Set up
Add:INDV ID
→Add:Group ID
DEL:INDV ID
DEL:Group ID
Offset time
MMSI Check
  
```

- ④ Set the group ID and ID name.
 - Edit the 8-digits of the group ID directly with the keypad.
 - Push the appropriate keypad several times to edit the character.
 - Rotate [CHANNEL] to move the cursor backward or forward.
 - Push [CE] to clear the ID and name.
 - Push [CLR] to cancel and exit the condition to DSC set up menu.

```

--DSC Menu--
Add:Individual ID
Input 8 digits
█
Input name
-----
  
```

- ⑤ Push [ENT] to program and exit the condition to DSC set up menu.

◆ Deleting group ID

- ① Push [MENU] to select the DSC menu.
- ② Rotate [CHANNEL] to select "Set up," push [ENT].
- ③ Rotate [CHANNEL] to select "DEL: Group ID," push [ENT].
 - When no group ID is programmed, the transceiver exits the condition automatically.

```

--DSC Menu--
Set up
Add:INDV ID
Add:Group ID
→DEL:INDV ID
DEL:Group ID
Offset time
MMSI Check
  
```

- ④ Rotate [CHANNEL] to select the desired ID name for deleting.
- ⑤ Push [ENT] to delete the group ID and exit the condition DSC set up menu.

■ Receiving DSC calls

◇ Receiving a distress call

While monitoring Channel 70 and a distress call is received:

- ➔ The emergency alarm sounds for 2 minutes.
 - Push any switch to stop the alarm.
- ➔ "Received Distress" appears in the display; then Channel 16 is automatically selected.
- ➔ Continue monitoring Channel 16 as a coast station may require assistance.

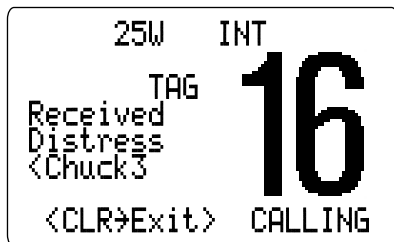

◇ Receiving a distress acknowledgement

While monitoring Channel 70 and a distress acknowledgement to other ship is received:

- ➔ The emergency alarm sounds for 2 minutes.
 - Push any switch to stop the alarm.
- ➔ "Received Distress ACK" appears in the display; then Channel 16 is automatically selected.

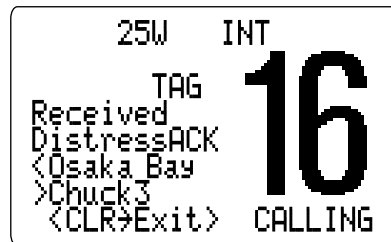

◇ Receiving an all ships call

While monitoring Channel 70 and an all ships call is received:

- ➔ The emergency alarm sounds when the category is 'Distress' or 'Urgency'; 3 beeps sound for other categories.
- ➔ "Received ALL SHIPS" appears in the display; then Channel 16 is automatically selected for voice communication.
- ➔ Monitor channel 16 for an announcement from the calling vessel.

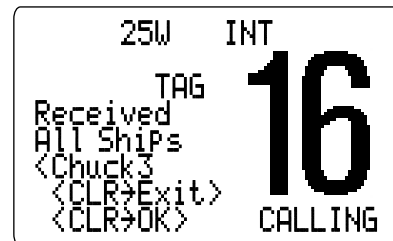

◇ Receiving an individual call

While monitoring Channel 70 and an individual call is received:

- The emergency alarm or beeps sound depending on the received category.
- “Received Individual” appears in the display.
- Push [ENT] to change to the channel specified by the calling station for voice communication; push [CLR] to ignore the individual call.

```

25W  INT
      TAG
Received Individual
<Chuck3
<CLR>Exit>
<ENT>OK> 10 COMMERCIAL
  
```

◇ Receiving a position request call

While monitoring Channel 70 and a position request call is received:

- “Received POS REQ” appears in the display.
- Push [ENT] to reply to the call.

```

25W  INT
      TAG
Received POS REQ
<Chuck3
<CLR>Exit>
<ENT>Reply> 08 COMMERCIAL
  
```

◇ Receiving a polling request call

While monitoring Channel 70 and a polling request call is received:

- “Received POLL REQ” appears in the display.
- Push [ENT] to reply to the call.

```

25W  INT
      TAG
Received POLL REQ
<Chuck3
<CLR>Exit>
<ENT>Reply> 08 COMMERCIAL
  
```

6 DSC OPERATION

■ DSC set mode

◇ Offset time

This item sets the offset time from the UTC (Universal Time Coordinated) time.

- ① Push [MENU] to enter the DSC menu.
- ② Rotate [CHANNEL] to select "Set up," push [ENT].

```
      --DSC Menu--  
Select item  
Position Request  
Polling Request  
Received Calls  
Distress Setting  
→Set up  
Exit
```

- ③ Rotate [CHANNEL] to select "Offset time," push [ENT].

```
      --DSC Menu--  
Set up  
Add:INDV ID  
Add:Group ID  
DEL:INDV ID  
DEL:Group ID  
→Offset time  
MMSI Check
```

- ④ Set the offset time from the UTC (Universal Time Coordinated) time.
 - Edit the digit of offset time directly with the keypad
 - Push [0] or [7] to edit or delete "--", when the cursor is on the first digit.
 - Rotate [CHANNEL] to move the cursor backward or forward.
 - Push [CE] to clear the time data.
 - Push [CLR] to cancel and exit the condition to DSC set up menu.

```
      --DSC Menu--  
Input Offset Time  
  0:--  
  ^
```

No offset time (default)

```
      --DSC Menu--  
Input Offset Time  
-12:00
```

-12 hours

- ⑤ Push [ENT] to program and to exit the condition to DSC set up menu.

/// The local time indication is not available when a GPS receiver (sentence formatter RMC) is input, the transceiver's display indicates UTC time only.

◆ MMSI code check

The programmed 9-digit MMSI (DSC self ID) code can be checked in DSC set mode.

- ① Push [MENU] to enter the DSC menu.
- ② Rotate [CHANNEL] to select "Set up," push [ENT].

```

--DSC Menu--
Select item
Position Request
Polling Request
Received Calls
Distress Setting
>Set up
Exit
  
```

- ③ Rotate [CHANNEL] to select "MMSI check," push [ENT].

```

--DSC Menu--
Set up
Add:INDU ID
Add:Group ID
DEL:INDU ID
DEL:Group ID
Offset time
>MMSI Check
  
```

- ④ Check the 9-digit MMSI (DSC self ID) code.

```

--DSC Menu--
MMSI Check
123456789

<CLR>Exit>
  
```

- ⑤ Push [CLR] or [ENT] to exit the condition to DSC set up menu.

6 DSC OPERATION

■ Received messages

The transceiver automatically stores up to 20 distress messages and 20 other messages. The messages can be used as an assistance to the logbook.

- ① Push [MENU] to select the DSC menu.
- ② Rotate [CHANNEL] to select "Received Calls," push [ENT].

```
      --DSC Menu--
Select item
  Position Request
  Polling Request
  →Received Calls
  Distress Setting
  Set up
  Exit
```

◇ Distress message

- ① Rotate [CHANNEL] to select "Distress," push [ENT].

```
      --DSC Menu--
Select Message
  →Distress
  Other

      <CLR>Exit / ENT→OK>
```

- ② Rotate [CHANNEL] to scroll to the desired message, push [ENT].
 - When some messages are blinking, the messages have not been read yet.

```
      --DSC Menu--
Select Item
  →16:00 Ricky
  14:55 Chuck3
  →12:34 Smith

      <CLR>Exit / ENT→OK>
```

- ③ Rotate [CHANNEL] to scroll the message.

<pre> --DSC Me Distress <Chuck3 MOB LAT: 23"45. 234 LON: 123"45. 456 <CLR>Exit /</pre>	<pre> --DSC Menu-- Distress MOB LAT: 23"45. 234N LON: 123"45. 456W UTC: 8:00 <CLR>Exit / CE→Del></pre>
---	---

- ④ Push [CLR] to exit the condition or push [CE] to clear the displayed message and returns to DSC menu.

◆ Other messages

- ① Rotate [CHANNEL] to select "Other," push [ENT].

```

--DSC Menu--
Select Message
Distress
→Other

<CLR>Exit / ENT→OK>

```

- ② Rotate [CHANNEL] to scroll to the desired message, push [ENT].

•When some messages are blinking, the messages have not been read yet.

```

--DSC Menu--
Select Message
>Position Request<
Individual Call
→Group Call
Individual Call

<CLR>Exit / ENT→OK>

```

- ③ Rotate [CHANNEL] to scroll the message.

•The stored message has various information and depending on the type of distress call.

--DSC Me	--DSC Menu--
Group Call	Group Call
<Chuck3	Routine
Routine	>OSAKA-1
>OSAKA-1	F3E simplex
F3E simplex	CH10
<CLR>Exit /	<CLR>Exit / CE→Del>

- ④ Push [CLR] to exit the condition or push [CE] to clear the displayed message and returns to DSC menu.

■ Intercom operation

The optional intercom function allows you to talk to the deck from the cabin. The optional HM-127 REMOTE-CONTROL MICROPHONE is required for intercom operation.

Connect an optional HM-127 as described on p. 62.

- Transmitting is impossible during intercom operation.
- The received signal is muted during intercom operation.

- ① Push [**F**], then push [9 IC] to enter intercom mode.
 - The HM-127 power is automatically turned ON, even if the power is OFF.



IC-M602

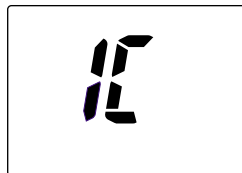

HM-127

- ② Push and hold [9 IC] again to call up.
 - The transceiver and microphone emit call beeps.

- ③ Push and hold [PTT] and speak at a normal voice level into the microphone.
 - "TALK" or "LISTEN" appears on the caller or listener function display, respectively.
 - To adjust the IC-M602's speaker output level, rotate [VOL].
 - To adjust the HM-127's speaker output level, push [▲]/[▼] after pushing [VOL].



IC-M602 (caller)



HM-127 (listener)

- ④ After releasing [PTT] you can hear the response through the speaker.
- ⑤ To return to normal operation, push [CLR] or repeat step ①.

- While in the intercom mode, the transceiver functions (transmit and receive) are interrupted. If the transceiver is in transmit condition, the intercom function is not available.
- When a DSC call is received, the intercom function is interrupted with an automatic return to the transceiver mode. The transceiver's display indicates 'Receiving DSC calls.' (p 34)

■ Hailer operation

The IC-M602 has a 2-way hailer function for voice amplification and reception over a loudspeaker, making it unnecessary to leave the bridge to hear a hailing party.

Connect an external hailer speaker as described on p. 49.

- Transmitting is not possible during hailer operation.
- The received signal is muted during hailer operation.

① Push [**F**], then push [7 HAIL] to enter hailer mode.



② Push and hold [PTT] and speak at a normal voice level into the microphone.

- “TALK” or “LISTEN” appears on the caller or listener function display, respectively.
- To adjust the hailer level, rotate [CHANNEL].

③ After releasing [PTT] you can hear the response through the speaker.

④ To return to normal operation, push [CLR] or repeat step ①.





- While in the hailer mode, the transceiver functions (transmit and receive) are interrupted. If the transceiver is in transmit condition, the hailer function is not available.
- When a DSC call is received, the hailer function is interrupted with an automatic return to the transceiver mode. The transceiver's display indicates 'Receiving DSC calls.' (p 34)

7 OTHER FUNCTIONS

■ Automatic fog horn

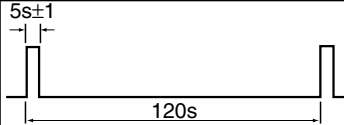
The automatic fog horn function sounds a horn repeatedly until the function is turned OFF. Four patterns are available for varying conditions.

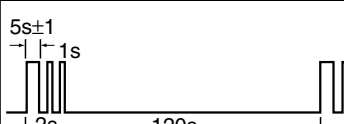
The fog horn outputs from the hailer speaker. To use this function, the hailer speaker must be connected to the transceiver. See p.49 for connection details.

TYPE	PATTERN	USAGE
UNDERWAY	One 5-second blasts every 120 seconds. 	Motor vessel underway and making way.
STOP	Two 5-second blasts (separated by 2 seconds) every 120 seconds. 	Motor vessel underway but stopped (not making way).
SAIL	One 5-second blast followed by two 1-second blasts (each separated by 2 seconds) every 120 seconds. 	Sailing vessel underway, fishing vessel (underway or anchored), vessel not under command, a vessel restricted in her ability to maneuver (underway or at anchor), or a vessel towing or pushing another ahead.
TOW	One 5-second blast followed by three 1-second blasts (each separated by 2-seconds) every 120 seconds. 	Vessel under tow (manned).

/// The audio frequency of the fog horn is selectable. See p.47 for details on selecting the audio frequency.

- ① Push [F], then push [8 FOG] to enter auto fog horn mode.
- ② Rotate [CHANNEL] to select the desired fog horn pattern, push [ENT].
 - 'UNDERWAY,' 'STOP,' 'SAIL,' 'TOW' are available. (p.42)
 - Even if [ENT] hasn't been pushed, the display automatically changes to the next step after 5 sec. of inactivity.

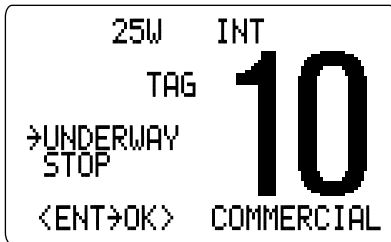

- ③ Rotate [CHANNEL] to adjust the fog horn level, push [ENT].
 - The fog horn level is adjustable in 7 steps.
 - Even if [ENT] hasn't been pushed, the display automatically changes to the next step after 5 sec. of inactivity.



- ④ To return to normal operation, repeat step ①.

When a DSC call is received, the automatic fog horn function is interrupted with an automatic return to the transceiver mode. The transceiver's display indicates 'Receiving DSC calls.' (p 34)

Microphone lock function

The microphone lock function electrically locks the [▲]/[▼] and [16/9] switches on the supplied microphone. This prevents accidental channel changes and accidental function access.

- While pushing [16/9] on the HM-136, turn power ON to toggle the lock function ON or OFF.

■ Set mode programming

Set mode is used to change the conditions of the transceiver's functions: scan type (normal or priority), scan resume timer, weather alert, dual/tri-watch of COMMANDMIC, transceiver's beep tone, internal speaker, LCD contrast, RF attenuation level, automatic fog horn frequency, scrambler type and scrambler code.

⚡ Available functions may differ depending on dealer setting.

- ① Turn power OFF.
- ② While pushing [16•9], turn power ON to enter set mode.
- ③ After the display appears, release [16•9].
- ④ Rotate [CHANNEL] to select the desired item, push [ENT].
Or push [16•9] to select the item when using an optional HM-127.
- ⑤ Rotate [CHANNEL] to select the desired condition of the item. Use [▲]/[▼] when using an optional HM-127.
- ⑥ Rotate [CHANNEL] to select "Exit," push [ENT] to exit set mode and returns to normal operation condition

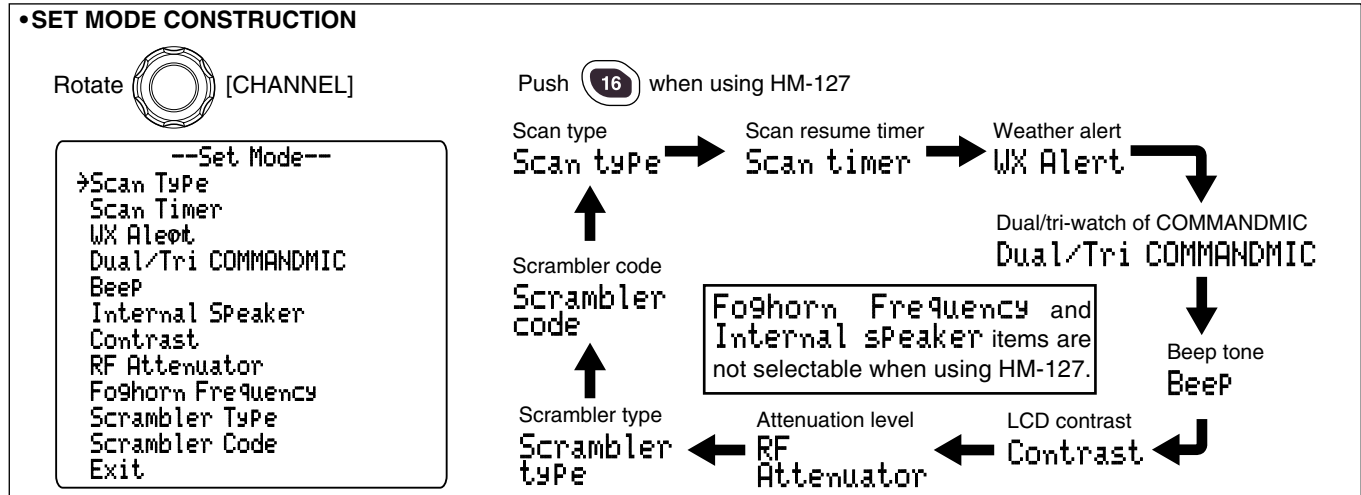

■ Set mode items

◇ Scan type

The transceiver has 2 scan types: normal scan and priority scan. Normal scan searches all tag channels in the selected channel group. Priority scan searches all tag channels in sequence while monitoring Channel 16.

```

--Set Mode--
Scan Type
Priority
➔Normal
  
```

(Default: Normal)

<ENT>OK>

◇ Scan resume timer

The scan resume timer can be selected as a pause (OFF) or timer scan (ON). When OFF is selected, the scan pauses until the signal disappears. When ON is selected, the scan pauses 5 sec. and resumes even if a signal has been received on channels except for Channel 16.

```

--Set Mode--
Scan Timer
ON
➔OFF
  
```

(Default: OFF)

<ENT>OK>

◇ Weather alert

An NOAA broadcast station transmits a weather alert tone before important weather information. When the weather alert function is turned ON, the transceiver detects the alert, then flashes the "WX ALERT" indicator until the transceiver is operated. The previously selected (used) weather channel is checked any time during standby or while scanning.

• "WX ALERT" appears instead of "WX" indication when the function is set ON.

```

--Set Mode--
WX Alert
ON
ON with WX SCAN
➔OFF
  
```

(Default: OFF)

<ENT>OK>

◇ Dual/Tri-watch of COMMANDMIC (Appears when connecting HM-127)

This item sets the HM-127's [CH/WX•DW] switch function as dual watch or tri-watch.

```

--Set Mode--
Dual/Tri COMMANDMIC
Tri-watch
➔Dualwatch
  
```

(Default: Dualwatch)

<ENT>OK>

8 SET MODE

◆ Beep tone

You can select silent operation by turning beep tones OFF, or you can have confirmation beeps sound at the push of a switch by turning beep tones ON.

```
      --Set Mode--  
Beep  
→ON  
OFF  
  
      <ENT>OK>
```

(Default: ON)

/// The optional HM-127 has it's own setting for the beep tone.

◆ Internal speaker

When an external speaker is connected and the transceiver's internal speaker is not required, the speaker on the transceiver and microphone can be deactivated.

```
      --Set Mode--  
Internal Speaker  
→ON  
OFF  
  
      <ENT>OK>
```

(Default: ON)

◆ LCD contrast

This item adjusts the contrast of the LCD in 8 steps.

```
      --Set Mode--  
Contrast  
→5  
4  
3  
2  
1  
  
      <ENT>OK>
```

(Default: 5)

/// The optional HM-127 has it's own setting for the LCD contrast.

◆ Attenuation level

This item sets the receive attenuation level for the attenuator function from 3 levels.

```
      --Set Mode--  
RF Attenuator  
Max  
Mid  
→Min  
  
      <ENT>OK>
```

(Default: Min)

◇ Automatic fog horn frequency

The audio frequency of the automatic fog horn can be adjusted to suit your preference. While this item is selected, pushing [PTT] outputs the fog horn—experiment with the frequencies available until you find one you like.

• Available frequency range is 200 Hz to 850Hz in 50 Hz step.

```

--Set Mode--
Foghorn Frequency
➔400
 350
 300
 250
 200
      <ENT>OK>
  
```

(Default: 400)

◇ Scrambler type

(Appears when a scrambler unit is installed)

When an optional scrambler unit is installed, the scrambler type can be selected in set mode depending on dealer setting.

```

--Set Mode--
Scrambler Type
 UT-98
 ➔UT-112
      <ENT>OK>
  
```

(Default: UT-112)

/// Although the UT-98 is not listed on the option list, M602 would take UT-98 as well as UT-112.

◇ Scrambler code

(Appears when a scrambler unit is installed)

When an optional scrambler unit is installed, the scrambler code can be set depending on dealer setting.

When the UT-112 is installed, 32 codes (1 to 32) can be selected.

```

--Set Mode--
Scrambler Code
 5
 4
 3
 2
 ➔1
      <ENT>OK>
  
```

(Default: 1)

■ Supplied accessories

The following accessories are supplied

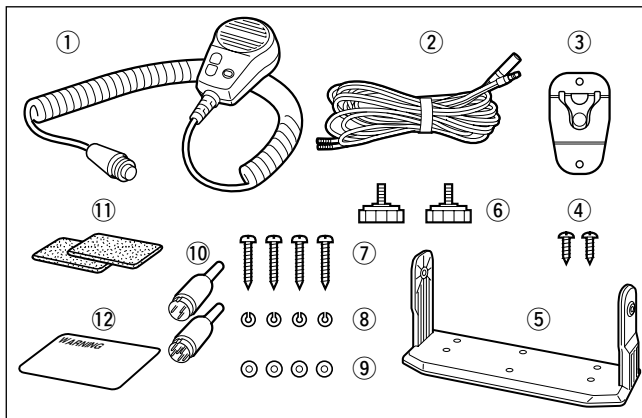

	Qty.
① Microphone (HM-136)	1
② DC power cable (OPC-1174)	1
③ Microphone hanger	1
④ Mic hanger screws (3 × 16)	2
⑤ Mounting bracket	1
⑥ Knob bolts for mounting bracket	2
⑦ Mounting screws (5 × 20)	4
⑧ Spring washers (M5)	4
⑨ Flat washers (M5)	4
⑩ Accessory connectors (3 pin, 6 pin)	1 each
⑪ Sponges	2
⑫ Warning sticker	1

■ Antenna

A key element in the performance of any communication system is an antenna. Ask your dealer about antennas and the best places to mount them.

■ Fuse replacement

One fuse is installed in the supplied DC power cable. If a fuse blows or the transceiver stops functioning, track down the source of the problem, if possible, and replace the damaged fuse with a new, rated one.

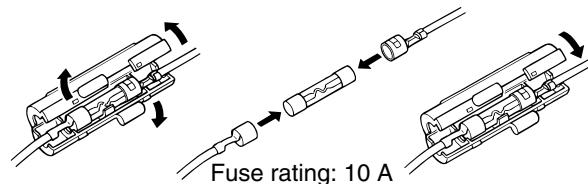

■ Cleaning

If the transceiver becomes dusty or dirty, wipe it clean with a soft, dry cloth.



AVOID the use of solvents such as benzene or alcohol, as they may damage transceiver surfaces.

■ Connections

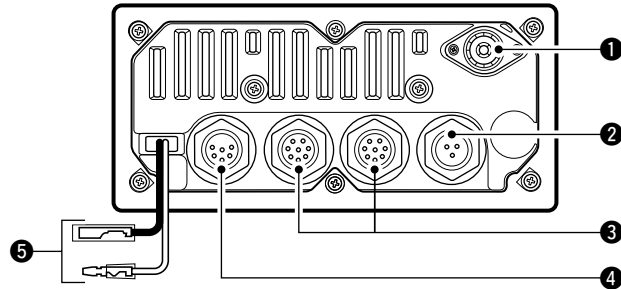

1 ANTENNA CONNECTOR

Connects a marine VHF antenna with a PL-259 connector.

CAUTION: Transmitting without an antenna may damage the transceiver.

2 HAILER/FOG HORN CONNECTOR

Connects to a hailer speaker.

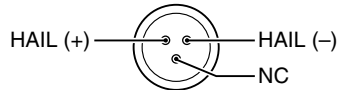

3 EXTERNAL MICROPHONE JACKS

Connects to optional HM-127 REMOTE-CONTROL MICROPHONE.

CAUTION: NEVER connect other microphones, such as the HM-136, as this may cause damage to the transceiver.

4 GPS RECEIVER/EXTERNAL SPEAKER JACK

Connects to a GPS receiver for position and time indications.

- An NMEA0183 ver. 2.0 (sentence formatters RMC, GGA, GNS, GLL) compatible GPS receiver is required. Ask your dealer about suitable GPS receivers.

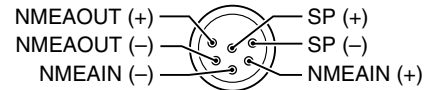

Connects to a PC or navigation equipment (NMEA0183 ver. 3.01 sentence formatters DSC, DSE compatible) for plotting received other ships position data.

Connects to an external speaker.

5 DC POWER CONNECTOR

Connects the supplied DC power cable from this connector to an external 13.8 V DC power source.

CAUTION: After connecting the DC power cable, cover the connectors with a rubber vulcanising tape as shown below, to prevent water seeping into the transceiver.

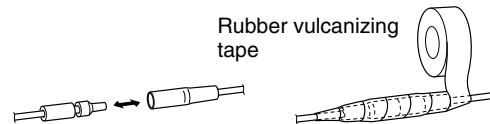

■ Mounting the transceiver

◆ Using the supplied mounting bracket

The universal mounting bracket supplied with your transceiver allows overhead or onboard mounting.

- Mount the transceiver securely with the 4 supplied screws (M5 × 20) to a surface which is more than 10 mm thick and can support more than 5 kg.
- Mount the transceiver so that the face of the transceiver is at 90° to your line of sight when operating it.

/// **CAUTION: KEEP** the transceiver and microphone at least 1 meter away from your vessel's magnetic navigation compass.

/// **NOTE:** Check the installation angle; the function display may not be easy-to-read at some angles.

/// **NOTE:** When mounting the transceiver on the place that is prone to strong vibration, use the supplied sponges between the transceiver and mounting bracket for reducing the effect of the vibration.

• OVERHEAD MOUNTING

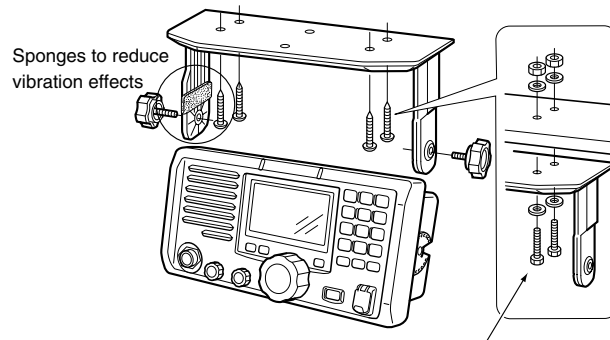

These screws are shown as mounting example only.
Not supplied with accessories.

• MOUNTING ON THE BOARD

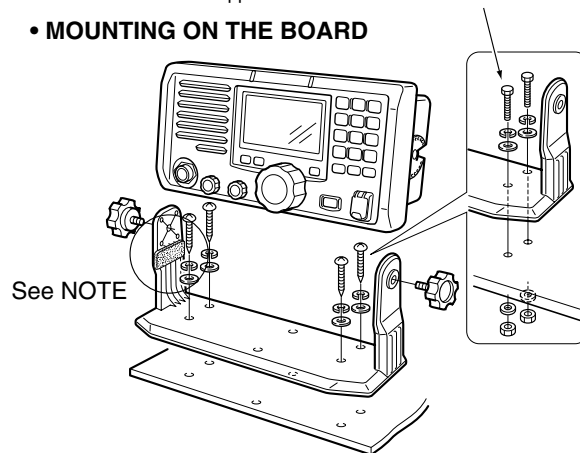

◆ **Using the optional MB-75**

An optional MB-75 FLUSH MOUNT is available for mounting the transceiver to a flat surface such as an instrument panel.

CAUTION: KEEP the transceiver and microphone at least 1 meter away from your vessel's magnetic navigation compass.

- ① Using the attached template, carefully cut a hole into the instrument panel (or wherever you plan to mount the transceiver).
- ② Slide the transceiver through the hole as shown below.

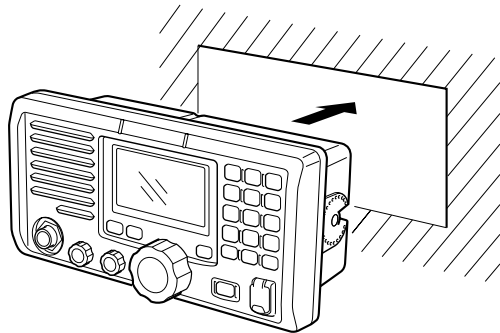

- ③ Attach the 2 supplied bolts (M5 × 8 mm) on either side of the IC-M602.

- ④ Attach the clamps on either side of the IC-M602.
 - Make sure that the clamps align parallel to the IC-M602's body.

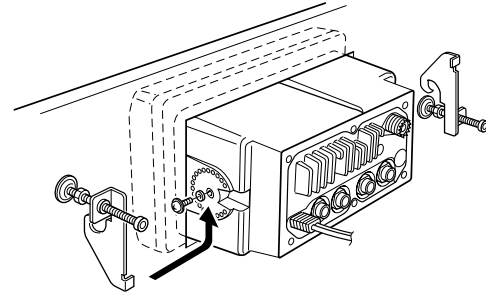

- ⑤ Tighten the end bolts on the clamps (rotate clockwise) so that the clamps press firmly against the inside of the instrument control panel.
- ⑥ Tighten the locking nuts (rotate counterclockwise) so that the IC-M602 is securely mounted in position as below.
- ⑦ Connect the antenna and control cable, then return the instrument control panel to its original place.

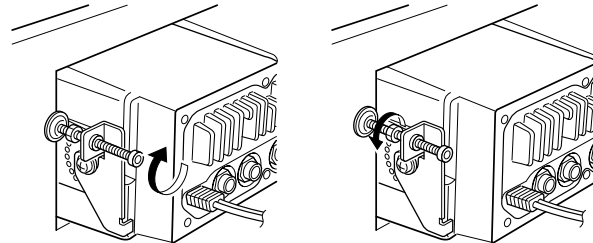

9 CONNECTIONS AND MAINTENANCE

■ Optional unit installation

CAUTION: DISCONNECT the DC power cable from the transceiver before performing any work on the transceiver. Otherwise, there is danger of electric shock and/or equipment damage.

Follow the case opening procedure shown here when you want to install an optional unit, etc.

- ① Remove the 12 screws as shown below and open the transceiver.

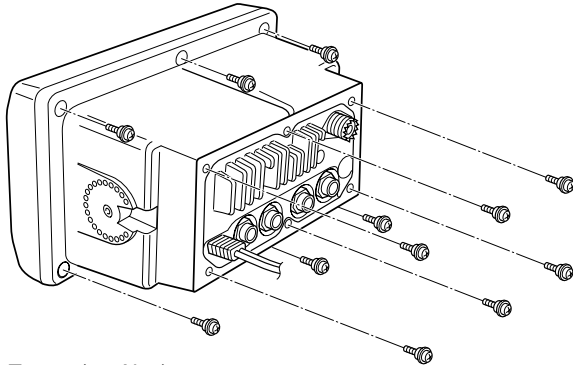

Torque (0.7 N.m)

- ② Plug an optional unit (UT-112) to J3 on the AF unit as shown below.

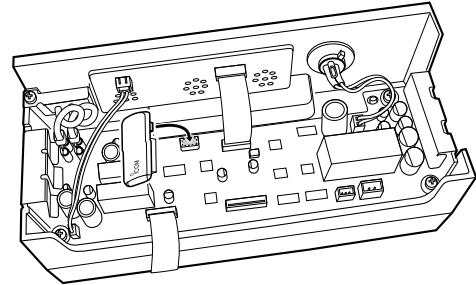

- ③ Assemble the units to their original positions.

CAUTION:

- When re-assembling the case and tightening the screws, you must keep the specified torque (0.7 N.m). Otherwise the transceiver may be damaged (torque too high) or lose waterproof efficiency (torque too low).
- When uninstalling the optional unit, remove it vertically. Wiggling the unit from side to side may damage the optional unit's connector.

■ Dimensions

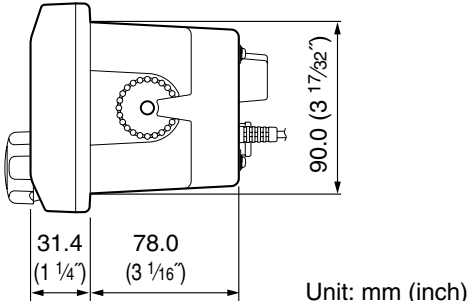
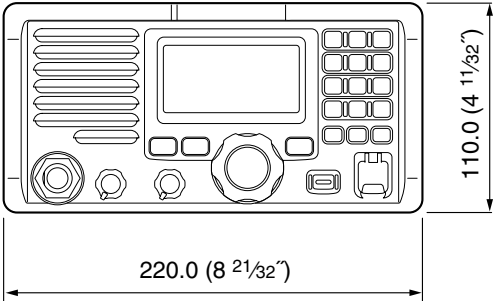
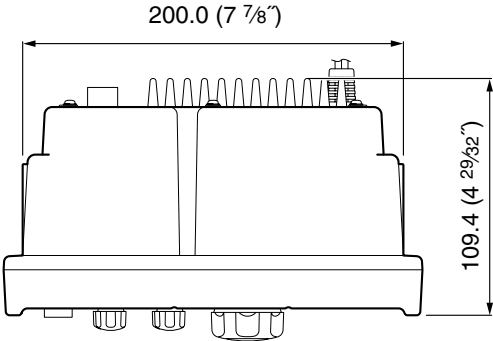

10 TROUBLESHOOTING

PROBLEM	POSSIBLE CAUSE	SOLUTION	REF.
No power comes ON.	<ul style="list-style-type: none">•Bad connection to the power supply.	<ul style="list-style-type: none">•Check the connection to the transceiver.	p. 49
No sound comes from the speaker.	<ul style="list-style-type: none">•Squelch level is too deep.•Volume level is too low.•Speaker has been exposed to water.•Internal speaker is turned OFF.	<ul style="list-style-type: none">•Set squelch to the threshold point.•Set [VOL] to a suitable level.•Drain water from the speaker.•Turn the internal speaker ON in set mode.	p. 10 p. 10 — p. 46
Sensitivity is low.	<ul style="list-style-type: none">•The attenuator is activated.	<ul style="list-style-type: none">•Push [F], then [6 LO/DX] to turn the function OFF.	p. 10
Transmitting is impossible, or high power cannot be selected.	<ul style="list-style-type: none">•Some channels are for low power or receive only.•The output power is set to low.	<ul style="list-style-type: none">•Change channels.•Push [H/L] to select high power.	pgs. 8, 55 p. 10
Scan does not start.	<ul style="list-style-type: none">•“TAG” channel is not programmed.	<ul style="list-style-type: none">•Set the desired channels as “TAG” channels.	p. 17
No beep sounds.	<ul style="list-style-type: none">•Beep tone is turned OFF.•The squelch is open.	<ul style="list-style-type: none">•Turn the beep tone ON in set mode.•Set squelch to the threshold point.	p. 46 p. 10
Receive signal cannot be understood.	<ul style="list-style-type: none">•Optional voice scrambler is turned OFF.•Scramble code is not set correctly.	<ul style="list-style-type: none">•Turn the optional voice scrambler ON.•Reset the scramble code.	p. 13 p. 47
Distress call cannot be transmitted.	<ul style="list-style-type: none">•MMSI (DSC self ID) code is not programmed.	<ul style="list-style-type: none">•Program the MMSI (DSC self ID) code.	p. 18

CHANNEL LIST 11

Channel number			Frequency (MHz)	
USA	INT	CAN	Transmit	Receive
	01	01	156.050	160.650
01A			156.050	156.050
	02	02	156.100	160.700
	03	03	156.150	160.750
03A			156.150	156.150
	04		156.200	160.800
		04A	156.200	156.200
	05		156.250	160.850
05A		05A	156.250	156.250
06	06	06	156.300	156.300
	07		156.350	160.950
07A		07A	156.350	156.350
08	08	08	156.400	156.400
09	09	09	156.450	156.450
10	10	10	156.500	156.500
11	11	11	156.550	156.550
12	12	12	156.600	156.600
13 [†]	13	13 [†]	156.650	156.650
14	14	14	156.700	156.700
15 [†]	15 [†]	15 [†]	156.750	156.750
16	16	16	156.800	156.800
17 [†]	17	17 [†]	156.850	156.850
	18		156.900	161.500
18A		18A	156.900	156.900
	19		156.950	161.550

Channel number			Frequency (MHz)	
USA	INT	CAN	Transmit	Receive
19A		19A	156.950	156.950
20	20	20 [†]	157.000	161.600
20A			157.000	157.000
	21	21	157.050	161.650
21A		21A	157.050	157.050
		21b	Rx only	161.650
	22		157.100	161.700
22A		22A	157.100	157.100
	23	23	157.150	161.750
23A			157.150	157.150
24	24	24	157.200	161.800
25	25	25	157.250	161.850
		25b	Rx only	161.850
26	26	26	157.300	161.900
27	27	27	157.350	161.950
28	28	28	157.400	162.000
		28b	Rx only	162.000
	60	60	156.025	160.625
	61		156.075	160.675
61A		61A	156.075	156.075
	62		156.125	160.725
		62A	156.125	156.125
	63		156.175	160.775
63A			156.175	156.175
	64	64	156.225	160.825

Channel number			Frequency (MHz)	
USA	INT	CAN	Transmit	Receive
64A		64A	156.225	156.225
	65		156.275	160.875
65A	65A	65A	156.275	156.275
	66		156.325	160.925
66A	66A	66A [†]	156.325	156.325
67 [†]	67	67	156.375	156.375
68	68	68	156.425	156.425
69	69	69	156.475	156.475
70 [†]	70 [†]	70 [†]	156.525	156.525
71	71	71	156.575	156.575
72	72	72	156.625	156.625
73	73	73	156.675	156.675
74	74	74	156.725	156.725
77 [†]	77	77 [†]	156.875	156.875
	78		156.925	161.525
78A		78A	156.925	156.925
	79		156.975	161.575
79A		79A	156.975	156.975
	80		157.025	161.625
80A		80A	157.025	157.025
	81		157.075	161.675
81A		81A	157.075	157.075
	82		157.125	161.725
82A		82A	157.125	157.125
	83	83	157.175	161.775

Channel number			Frequency (MHz)	
USA	INT	CAN	Transmit	Receive
83A		83A	157.175	157.175
		83b	Rx only	161.775
84	84	84	157.225	161.825
84A			157.225	157.225
85	85	85	157.275	161.875
85A			157.275	157.275
86	86	86	157.325	161.925
86A			157.325	157.325
87	87	87	157.375	161.975
87A			157.375	157.375
88	88	88	157.425	162.025
88A			157.425	157.425
WX channel		Frequency (MHz)		
		Transmit	Receive	
1		RX only	162.550	
2		RX only	162.400	
3		RX only	162.475	
4		RX only	162.425	
5		RX only	162.450	
6		RX only	162.500	
7		RX only	162.525	
8		RX only	161.650	
9		RX only	161.775	
10		RX only	163.275	

[†]Low power only. [‡]Receive only.

NOTE: Simplex channels, 3, 21, 23, 61, 64, 81, 82 and 83 **CANNOT** be lawfully used by the general public in U.S.A. waters.

12 SPECIFICATIONS AND OPTIONS

■ Specifications

◇ General

- Frequency coverage :
 - Transmit 156.025–157.425 MHz
 - Receive 156.050–163.275 MHz
- Mode : FM (16K0G3E)
DSC (16K0G2B)
- Current drain (at 13.8 V) : TX high (25 W) 5.2 A typical
Max. audio 1.2 A typical
- Power supply requirement: 13.8 V DC \pm 15%
(negative ground)
- Frequency stability : \pm 5 ppm
(-20°C to $+60^{\circ}\text{C}$;
 -4°F to $+140^{\circ}\text{F}$)
- Antenna impedance : 50 Ω nominal
- Input impedance (MIC) : 2 k Ω
- Output impedance (audio): 4 Ω
- Intermediate frequencies : 1st; 31.05 MHz, 2nd; 450 kHz
(CH 70 receiver) 1st; 21.7 MHz, 2nd; 450 kHz
- Dimensions : 220(W) \times 110(H) \times 109.4(D) mm
(Projections not included) 8^{21/32}(W) \times 4^{11/32}(H) \times 4^{5/16}(D) in
- Weight : 1350 g; 2 lb 16 oz

◇ Transmitter

- RF output power : 25 W and 1 W
- Modulation system : Variable reactance frequency modulation
- Max. frequency deviation : \pm 5.0 kHz
- Spurious emissions : Less than -70 dBc
- Adjacent channel power : More than 70 dB
- Audio harmonic distortion : Less than 10%
(at 1 kHz, 60% deviation)
- Residual modulation : More than 40 dB
- Audio frequency response: $+1$ to -3 dB of 6 dB/octave
range from 300 Hz to 3000 Hz

◇ Receiver

- Receive system : Double conversion superheterodyne
- Sensitivity (12 dB SINAD) : Less than 0.32 μV
Less than 0.32 μV
(CH 70 receiver)
- Squelch sensitivity : Less than 0.32 μV
- Spurious response : More than 80 dB
- Intermodulation : More than 80 dB
- Adjacent channel selectivity: More than 80 dB
- Hum and noise : More than 40 dB
- Audio output power : 5 W typical at 10% distortion
with a 4 Ω load

All stated specifications are subject to change without notice or obligation.

■ Options

- **MB-75 FLUSH MOUNT** (p. 51)

For mounting the transceiver to a panel.

- **UT-112 VOICE SCRAMBLER UNIT** (pgs. 13, 47)

Ensures private communications. 32 codes are available. Not available in some countries.

- **HM-127 REMOTE-CONTROL MICROPHONE** (p. 58)

External microphone-type controller. Provides optional intercom operation. 6 m (20 feet) microphone cable and mounting base included. Black and white colors are available.

- **HM-136 SMART-SPEAKER-MICROPHONE** (p. 7)

Same as supplied. Black and white colors are available.

- **OPC-999 MICROPHONE EXTENSION CABLE**

6 m (20 feet) microphone extension cable for optional HM-127. Up to 2 OPC-999 can be connected. (18 m; 60 feet maximum)

■ Panel description

The optional HM-127 remotely controls the IC-M602 and provides an optional intercom function.

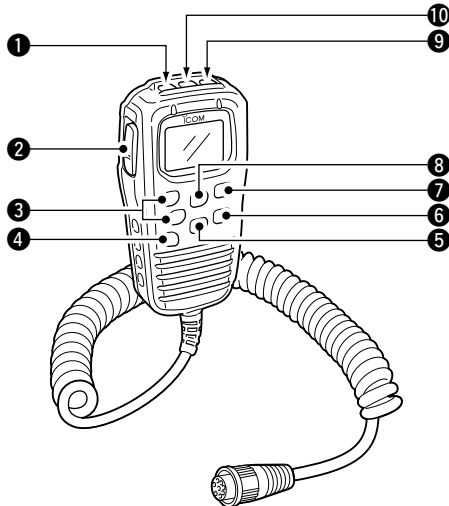

- 1 POWER SWITCH [PWR]** (pgs. 10, 65)
Push for 2 sec. to turn the HM-127 power ON or OFF when the IC-M602 power is turned ON.

- 2 PTT SWITCH [PTT]** (pgs. 10, 65)
Push and hold to transmit; release to receive.
- 3 CHANNEL UP/DOWN SWITCHES [▲]/[▼]**
- Push either switch to change the operating channel, set mode contents, etc. (pgs. 10, 65)
 - Push either switch to adjust audio level or noise squelch level after [VOL] or [SQL] is pushed, respectively. (pgs. 10, 65)
 - Push either switch to adjust the brightness of the LCD and switch backlight after [VOL] is pushed for 1 sec. (p. 66)
 - In set mode, changes setting of the selected item. (pgs. 44, 69)
 - Checks tag channels or changes scanning direction during scan. (pgs. 17, 68)
- 4 CHANNEL 16/CALL CHANNEL SWITCH [16•9]**
- Selects channel 16 when pushed. (pgs. 8, 64)
 - Selects call channel when pushed for 1 sec. (pgs. 8, 64)
 - “CALL” appears when call channel is selected.
 - Push for 3 sec. to enter call channel programming condition when call channel is selected. (pgs. 11, 67)
 - While pushing [H/L], enters memory name programming condition. (pgs. 11, 70)
 - Enters set mode when pushed while turning power ON. (pgs. 44, 69)
- 5 CHANNEL/DUALWATCH/TRI-WATCH SWITCH [CH/WX•DW•U/I/C]**
- Selects and toggles the regular channels and weather channel when pushed momentarily. (pgs. 9, 64)

- While pushing [H/L], selects one of 3 regular channels in sequence when pushed. (pgs. 9, 64)
 - International, U.S.A. and Canadian channels are available for regular channels.

- Starts dualwatch or tri-watch when pushed for 1 sec. (pgs. 15, 68)
- Stops dualwatch or tri-watch when either is activated.

6 ATTENUATOR/INTERCOM/SCRAMBLER SWITCH [LO/DX•IC•SCR]

- Toggles the attenuator function ON or OFF when pushed momentarily. (pgs. 10, 65)
 - “LOCAL” appears when the attenuator is in use.
- Activates the intercom function when pushed for 1 sec. (pgs. 40, 70)
- Calls the IC-M602 when pushed and held while in intercom mode. (pgs. 40, 70)
- While pushing [H/L], activates an optional voice scrambler function. (pgs. 13, 67)
 - The optional voice scrambler function cannot be used on channel 16 and 70.

7 SQUELCH/MONITOR/LOCK SWITCH [SQL•MONI•L]

- [▲]/[▼] sets the squelch threshold level after pushing [SQL]. (p. 65)
- Push [SQL•MONI] for 1 sec. to turn the monitor function ON. (p. 66)
- While pushing [H/L], push [SQL•MONI•L] to toggle the microphone key lock function ON or OFF. (p. 66)
 - “” appears while key lock function is in use.

- [PWR], [PTT], [VOL], [SQL] and [H/L] still function when the microphone key lock function is turned ON.

- Advance the cursor while in memory name programming condition. (pgs. 11, 70)

8 VOLUME/DIMMER SWITCH [VOL•DIM]

- [▲]/[▼] adjusts the audio level after pushing [VOL].
- Push [VOL•DIM] for 1 sec. to adjust the brightness of the LCD and switch backlight. (p. 66)
- Move the cursor backward while in memory name programming condition. (pgs. 11, 70)

9 TRANSMIT POWER SWITCH [H/L]

- Toggles high or low power when pushed. (pgs. 10, 65)
 - Some Channels are set to low power only.
- While pushing this switch, other switches perform secondary functions.
- Toggles the all key lock function ON or OFF when pushed while turning power ON. (p. 66)
 - “” flashes while the all key lock function is in use.
 - Only [PWR] and [PTT] function when the all key lock function is in use.

10 SCAN SWITCH [SCN•TAG] (pgs. 17, 68)

- Starts and stops normal or priority scan when tag channels are programmed.
- Push [SCN•TAG] for 1 sec. to set the displayed channel as a tag (scanned) channel.
- While pushing [H/L], push for 3 sec. to clear all tag channels.

■ Function display

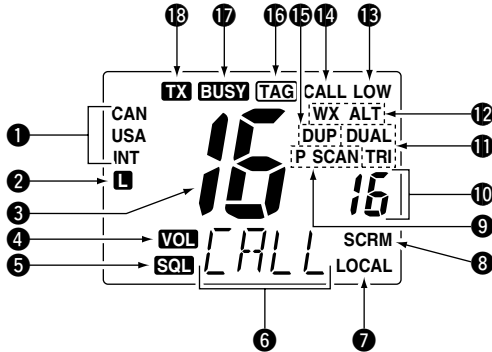

- 1 CHANNEL GROUP INDICATOR** (pgs. 9, 64)
Indicates whether an International (INT), U.S.A. (USA) or Canadian (CAN) channel is selected.
- 2 KEY LOCK INDICATOR** (p. 66)
 - Appears while the key lock function is in use.
 - Flashes while the all key lock function is in use.
- 3 CHANNEL NUMBER READOUT**
 - Indicates the selected operating channel number. "A" appears when a simplex channel is selected. "b" appears when a receive only channel for a Canadian channel group is selected. (pgs. 9, 64)

- In set mode, indicates the selected condition. (pgs. 44, 69)
- "IC" appears during intercom mode. (pgs. 40, 70)

- 4 VOLUME INDICATOR** (p. 65)
Appears while audio output level is adjusted.
- 5 SQUELCH INDICATOR** (p. 65)
Appears while noise squelch level is adjusted.
- 6 CHANNEL NAME INDICATOR**
 - Channel comment appears (and scrolls) if programmed. (pgs. 11, 70)
 - In set mode, indicates or scrolls the selected set mode item. (pgs. 44, 69)
- 7 ATTENUATOR INDICATOR** (pgs. 10, 65)
Appears when the RF attenuator is in use.
- 8 SCRAMBLER INDICATOR** (pgs. 13, 67)
Appears when an optional voice scrambler is activated.
- 9 SCAN INDICATOR** (pgs. 17, 68)
 - "SCAN" appears during normal scan.
 - "P SCAN" appears during priority scan.
- 10 PRIORITY CHANNEL INDICATOR**
 - Indicates a priority channel during priority scan or dual/tri-watch. (pgs. 14, 17, 68)

- ⑪ **DUAL/TRI WATCH INDICATOR** (pgs. 15, 68)
 “DUAL” appears during dualwatch; “TRI” during tri-watch.
- ⑫ **WEATHER CHANNEL INDICATOR** (pgs. 9, 64)
 - “WX” appears when a weather channel is selected.
 - “WX ALT” appears when the weather alert function is in use; flashes when an alert tone is received.
- ⑬ **LOW POWER INDICATOR** (pgs. 10, 65)
 Appears when low power is selected.
- ⑭ **CALL CHANNEL INDICATOR** (pgs. 8, 64)
 Appears when the call channel is selected.
- ⑮ **DUPLEX INDICATOR** (pgs. 9, 64)
 Appears when a duplex channel is selected.
- ⑯ **TAG CHANNEL INDICATOR** (pgs. 17, 68)
 Appears when a tag channel is selected.
- ⑰ **BUSY INDICATOR** (pgs. 10, 65, 66)
 Appears when receiving a signal or when the squelch opens.
- ⑱ **TRANSMIT INDICATOR** (pgs. 10, 65)
 Appears while transmitting.

■ HM-127 supplied accessories

Accessories included with the HM-127:	Qty.
① Connection cable (OPC-1000: 6 m; 20 ft)	1
② Mounting base	1
③ Microphone hanger	1
④ Screws (M3 × 16; tapping)	5

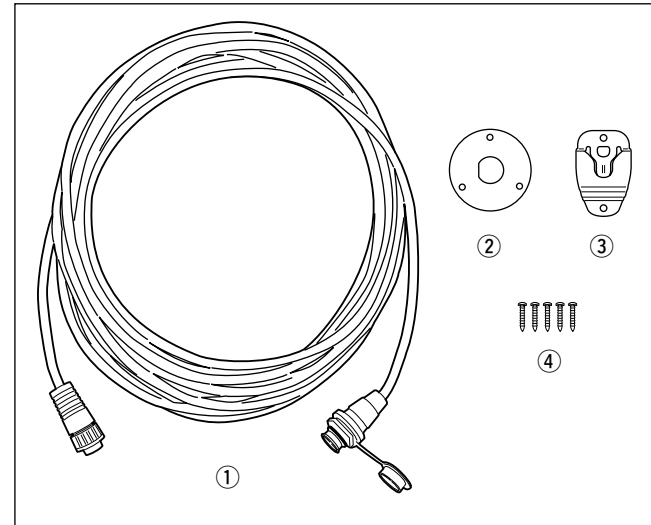

13 HM-127 REMOTE-CONTROL MICROPHONE

■ Installation

The optional HM-127 can be connected to the transceiver directly, as well as via the supplied connection cable for longer distance remote operation. The connector of the connection cable can be installed into a cabinet, wall, etc., as a built-in plug.

For longer distance remote operation, the optional extension cable, OPC-999 (6 m; 20 ft/connecting between transceiver and the connection cable), is available, and up to 2 OPC-999 can be added.

- ① Insert the supplied cable into the external microphone jack and tighten the cable nut as shown below.

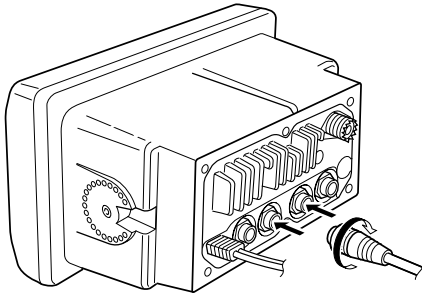

- ② To use the supplied cable as a wall socket, follow the below steps.
- ③ Using the mounting base, carefully mark off the 2 spots where the cable and screws will be fastened.
- ④ Drill holes at these marks.
- ⑤ Install the mounting base using the supplied screws as shown below.

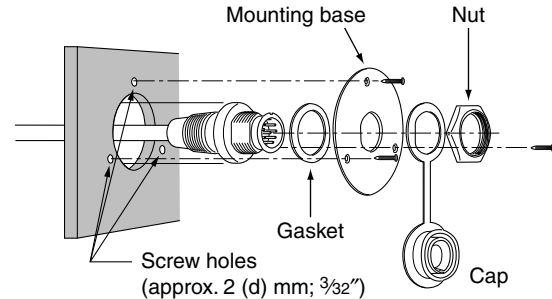

- ⑥ The completed installation should look like this.

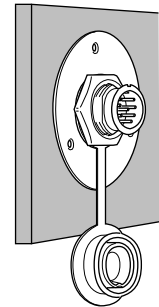

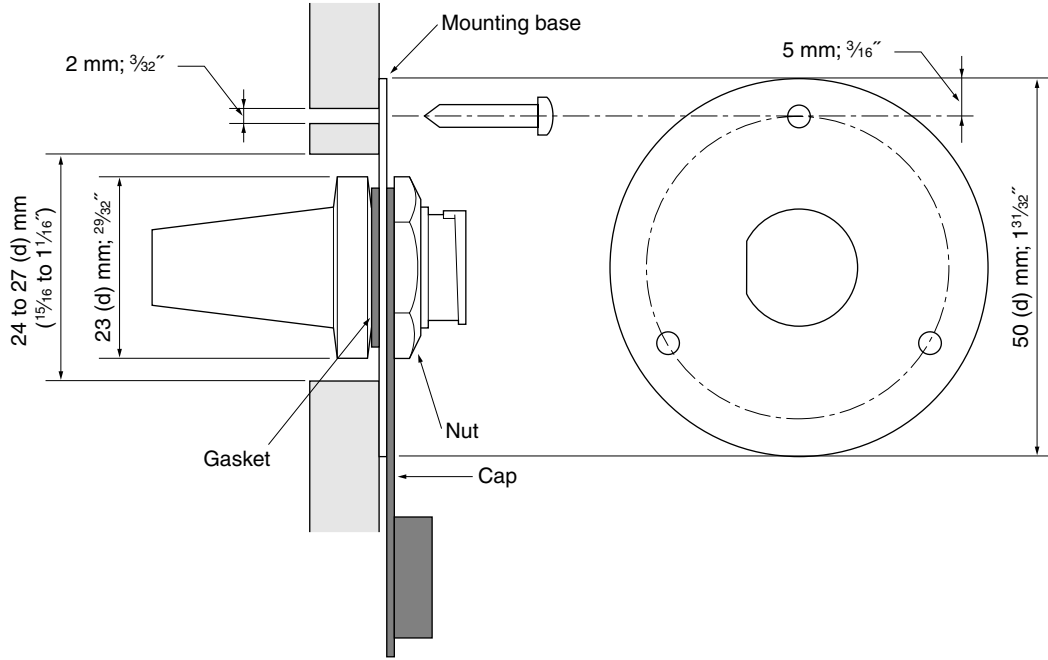

■ Channel selection

◆ Channel 16

- ① Push [16] to select Channel 16.
- ② Push [CH/WX] to return to the condition before selecting Channel 16, or push [▲] or [▼] to select an operating channel.



Push 

◆ Call channel

- ① Push [16•9] for 1 sec. to select the call channel.
- ② Push [CH/WX] to return to the condition before selecting the call channel, or push [▲] or [▼] to select an operating channel.

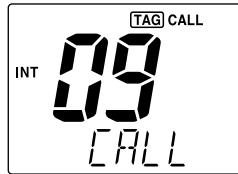

Push  9 for 1 sec.

◆ Weather channels

- ① Push [CH/WX] once or twice to select the weather channel group.
- ② Push [▲] or [▼] to select a weather channel.
- ③ Push [CH/WX] to return to the condition before selecting the weather channel group.

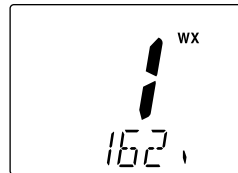

Push 

◆ U.S.A., International and Canadian channels

- ① Push [CH/WX] to select a regular channel.
 - Push [CH/WX] again, if a weather channel appears.
- ② Push [CH/WX•U/I/C], while pushing [H/L], to select a channel group.
 - U.S.A., International and Canadian channels can be selected in sequence.

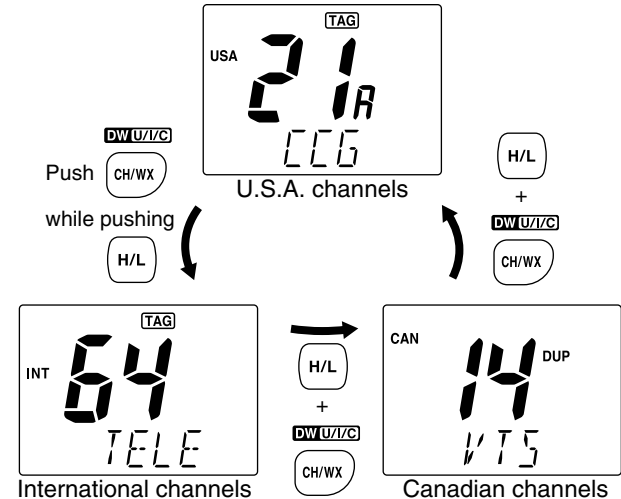

■ Receiving and transmitting

- ① Push [PWR] to turn power ON.
- ② Push [VOL], then [▲]/[▼] to adjust audio output level.
 - Push [SQL], then push [▲]/[▼] to mute any audio noise, if necessary.
- ③ Push [▲]/[▼] to select the desired channel.
 - When receiving a signal, “**BUSY**” appears and audio is emitted from the speaker.
 - Further adjustment of the audio level may be necessary at this point.
 - Use the optional voice scrambler function for privacy. (pgs. 13, 67)
- ④ Push [H/L] to select the output power, if necessary.
 - “**LOW**” appears when low power is selected.
 - Choose low power for shorter, high power for longer distance communications.
 - Some channels are low power only.

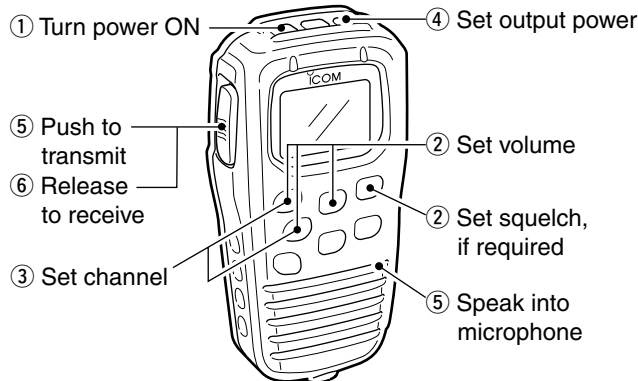

- ⑤ Push and hold [PTT] to transmit, then speak into the microphone.
 - “**TX**” appears.
 - Channel 70 cannot be used for transmission.

Simplex channels, 3, 21, 23, 61, 64, 81, 82 and 83 **CANNOT** be lawfully used by the general public in U.S.A. waters.

- ⑥ Release [PTT] to receive.

IMPORTANT: To maximize the readability of your transmitted signal (voice), pause a few sec. after pushing [PTT], hold the microphone 1 to 2 inches (2.5 to 5 cm) from your mouth and speak at a normal voice level.

■ RF attenuator function

- ➔ Push [LO/DX] to turn the RF attenuator function ON and OFF.



Appears when the RF attenuator function is in use

■ Lock functions

The lock function electronically locks keys and switches to prevent accidental changes and function access from the microphone.

• All keys, switches and controllers on the transceiver are functional.

◇ Activating the lock function

➔ Push [SQL] while pushing [H/L] to turn the lock function ON or OFF.

- “**L**” appears.
- Only [PWR], [PTT], [H/L], [SQL•MONI], [VOL]+[▲]/[▼] and [SQL]+[▲]/[▼] are functional.



Appears when the lock function is in use.

◇ Activating the all key lock function

➔ Turn the power ON by pushing [PWR] while pushing [H/L] to turn the all key lock function ON or OFF.

- “**L**” flashes.
- Only [PWR] and [PTT] are functional.



Flashes when the all lock function is in use.

■ Display backlighting

The function display and switches can be backlit for better visibility under low light conditions. The backlighting condition can also be adjusted independently from the transceiver.

① Push [VOL•DIM] for 1 sec. to enter backlight adjusting mode.

- “**7IM**” with the number of the backlight level appears in the channel name indicator.

② Push [▲]/[▼] to adjust the backlight level.

- The backlight level is adjustable between 0 (light OFF) and 7 (brightest).

■ Monitor function

The monitor function releases the noise squelch mute of the microphone only. (An independent noise squelch system is employed.)

➔ Push [SQL•MONI] for 1 sec. to activate the monitor function.

- “**BUSY**” flashes and audio is emitted.
- Any key cancels the monitor function.

■ Call channel programming

① Push [CH/WX•U/I/C] several times while pushing [H/L] to select the desired channel group (USA, INT, CAN) to be programmed.



② Push [16•9] for 1 sec. to select the call channel of the selected channel group.
•“CALL” and call channel number appear.

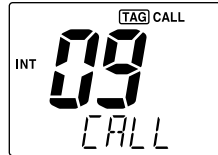

③ Push [16•9] again for 3 sec. (until a long beep changes to 2 short beeps) to enter call channel programming condition.
•Call channel number and channel group to be programmed flashes.

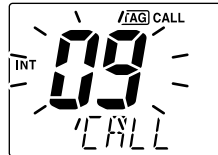

④ Push [▲]/[▼] to select the desired channel.

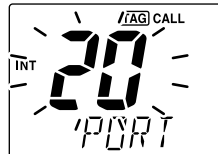

⑤ Push [16•9] to program the displayed channel as the call channel.
•The call channel number and channel group stop flashing.

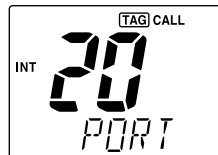

■ Optional voice scrambler operation

◇ Activating the scrambler

- ① Select an operating channel, except for Channel 16, Channel 70 or weather channels.
- ② Push [LO/DX•IC•SCR] while pushing [H/L] to turn the voice scrambler function ON.
•“SCRM” appears.
- ③ To turn the scrambler function OFF, repeat step ②.
•“SCRM” disappears.



Appears when the voice scrambler function is in use.

◇ Programming scramble codes

There are 32 codes (01 to 32) available with the UT-112 for programming. In order to understand one another, all transceivers in your group must have the same scrambler code. The scrambler code is programmed in set mode. See pgs. 13, 47 for details.

■ Starting a scan

- ① Push [CH/WX•U/I/C] several times while pushing [H/L] to select the channel group (USA, INT, CAN), if desired.
 - When the weather alert function is in use, select the desired weather channel with [CH/WX] and [▲]/[▼].
- ② Push [SCN] to start priority or normal scan.
 - “SCAN” appears during normal scan.
 - The priority channel readout indicates “16”, and “P” and “SCAN” indicators appear during priority scan.
 - When a signal is received, scan pauses until the signal disappears or resumes after pausing 5 sec. according to the set mode setting (Channel 16 is still monitored during priority scan).
 - Push [▲]/[▼] to check the scanning tag channels, to change the scanning direction or resume the scan manually.
- ③ To stop the scan, push [SCN].
 - “SCAN” disappears.
 - Pushing [PTT], [16•9] or [CH/WX] also stops the scan.

■ Setting tag channels

- ① Push [CH/WX•U/I/C] several times while pushing [H/L] to select the channel group (USA, INT, CAN), if desired.
- ② Push [▲]/[▼] to select the desired channel to set as a tag channel.
- ③ Push [SCN•TAG] for 1 sec. to set the displayed channel as a tag channel.
 - “TAG” appears.
- ④ To cancel the tag channel setting, push [SCN•TAG] for 1 sec.
 - “TAG” disappears.

•Clearing all tag channels in the selected channel group

- ➔ Push [SCN•TAG] while pushing [H/L] for 3 sec. (until a long beep changes to 2 short beeps).

■ Dualwatch/Tri-watch operation

- ① Push [▲]/[▼] to select the desired channel.
 - Push [CH/WX•U/I/C] several times while pushing [H/L] to select the channel group (USA, INT, CAN), if desired.
- ② Push [CH/WX•DW] for 1 sec. to start dualwatch or tri-watch.
 - “DUAL” appears during dualwatch; “TRI” appears during tri-watch.
 - A beep tone sounds when a signal is received on Channel 16.
 - Tri-watch becomes dualwatch when receiving a signal on the call channel.
 - Dualwatch or tri-watch can be selected in the transceiver’s set mode.
- ③ To cancel dualwatch/tri-watch, push [CH/WX•DW] again.

■ Set mode programming

Set mode is used to change the condition of the transceiver's functions and the microphone's own functions:

Transceiver's functions—

scan type (normal or priority), scan resume timer, weather alert, dualwatch/tri-watch of COMMANDMIC, transceiver's beep tone, internal speaker (transceiver), LCD contrast (transceiver), RF attenuation level, foghorn frequency, scrambler type and scrambler code.

Microphone's own functions—

beep tone function (microphone) and LCD contrast (microphone).

In this section, instructions are for the microphone's own functions only. Refer to pgs. 44–47 for the setting of the other functions. (Some functions cannot be selected from the microphone.)

◇ Entering set mode

- ① Turn power OFF.
- ② While pushing [16•9], turn power ON.
 - After a beep emission, a set mode item (in the channel name indicator and the condition in the channel number readout) is displayed.
- ③ Push [16•9] to select the desired item, if necessary.
- ④ Push [▲]/[▼] to select the desired condition of the item.
- ⑤ Turn power OFF, then ON to exit set mode.

• Beep tone “BEEP”

➔ Push [▲] to turn ON, [▼] to turn OFF the beep output.

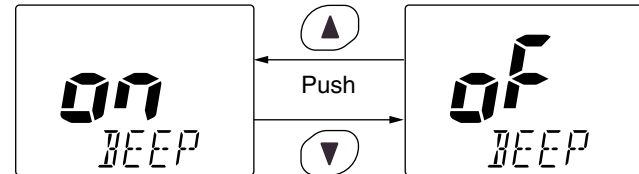

• LCD contrast “LCD CONTRAST”

➔ Push [▲]/[▼] to adjust to a suitable LCD contrast.

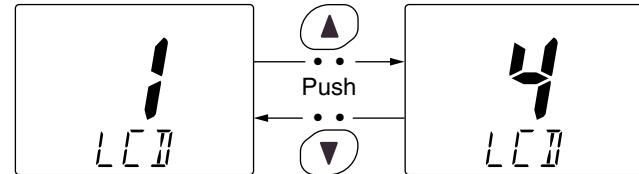

■ Intercom operation

- ① Push [LO/DX•IC] for 1 sec. to activate the intercom function.
 - "IC" appears in the channel readout.
 - The channel name disappears.
- ② Push [PTT] to talk.
 - "TRKR" appears in the channel name indicator.
- ③ Release [PTT] to listen.
 - "LSTN" appears in the channel name indicator when the transceiver is in talking mode.
- ④ Push [LO/DX•IC] to cancel the intercom function.
 - Pushing [16] also cancels the intercom function.

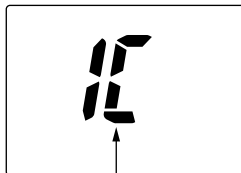

Appears when the intercom function is in use.

For your reference:

In case the intercom mode is selected with the transceiver while the microphone power is OFF, the microphone power is automatically turned ON and the intercom mode is selected.

◇ Intercom beep function

- ➡ Push [LO/DX•IC] for more than 1 sec.
 - Emits the intercom beep while holding.

■ Channel comments

- ① Push [▲]/[▼] to select a channel to program the channel comment.
 - Push [CH/WX•U/I/C] several times while pushing [H/L] to select the channel group (USA, INT, CAN), if desired.
- ② While pushing [H/L], push [16•9].
 - The 1st character of the currently programmed comment flashes.
- ③ Push [▲]/[▼] to select a character.
- ④ Push [SQL] to move to right; then push [▲]/[▼] to select a character.
 - Push [VOL] to move to left.
- ⑤ Continue until the desired characters have been selected, then push [16•9] to return to normal operation.

• Available characters

(space)	! (!)	" (")	# (#)	\$ (\$)	% (%)	& (&)	' (')	(())	! (!)
* (*)	+ (+)	, (,)	-- (-)	\ (\)	/ (/)	0 (0)	1 (1)	2 (2)	3 (3)
4 (4)	5 (5)	6 (6)	7 (7)	8 (8)	9 (9)	A (A)	B (B)	C (C)	D (D)
E (E)	F (F)	G (G)	H (H)	I (I)	J (J)	K (K)	L (L)	M (M)	N (N)
O (O)	P (P)	Q (Q)	R (R)	S (S)	T (T)	U (U)	V (V)	W (W)	X (X)
Y (Y)	Z (Z)	a (a)	b (b)	c (c)	d (d)	e (e)	f (f)	g (g)	h (h)
i (i)	j (j)	k (k)	l (l)	m (m)	n (n)	o (o)	p (p)	q (q)	r (r)
s (s)	t (t)	u (u)	v (v)	w (w)	x (x)	y (y)	z (z)		

HM-127 TEMPLATE

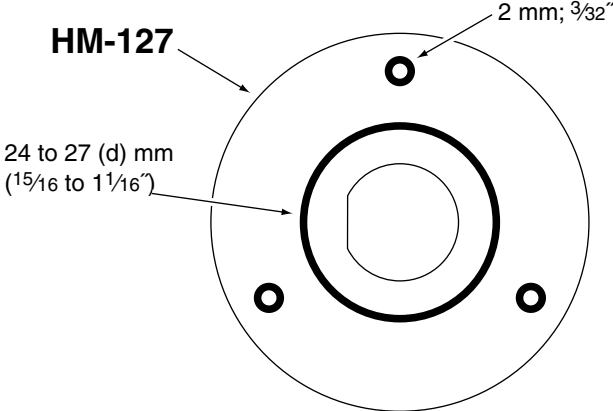

Cut here

Unit: mm (inch)

Count on us!

A-6217H-1EX-①
Printed in Japan
© 2002 Icom Inc.

Icom Inc.

1-1-32 Kamiminami, Hirano-ku, Osaka 547-0003 Japan